

AC-DC-AC-DC Converter Using Silicon Carbide Schottky Diode

Y. S. Ravikumar

Faculty of TE, SIT, Tumkur

Abstract: Silicon carbide (SiC) is the perfect cross between silicon and diamond. The crystal lattice of SiC is identical to silicon and diamond, but, exactly half the lattice sites are occupied by silicon atoms and half by carbon atoms. Like-diamond SiC has electronic properties superior to silicon, but, unlike diamond it is also manufacturable. The thermal leakage current (dark current) in SiC is sixteen orders-of magnitude lower as well. As temperature increases, the leakage current increases, but, the temperature where the leakage current would disrupt circuit operation is over 1000 °C in SiC, compared to about 250 °C in silicon. The SiC electronic revolution began in the early 1990's when single-crystal wafers became commercially available for the first time. During the intervening years, many different electronic devices have been demonstrated in SiC, with performance often exceeding the theoretical limits of silicon. These include pin diodes, MOS field-effect transistors (MOSFETs), metal-semiconductor field-effect transistors (MESFETs), and bipolar transistors (BJTs), as well as specialized devices such as CCD imagers, Schottky diodes, static induction transistors (SITS) and impact-ionization- avalanche-transit-time (MATT) microwave oscillators. These early digital logic gates and linear elements are based on n-channel MOS technology, but, quickly followed by more sophisticated CMOS integrated circuits.

Key words: DC-DC Converter, Energy band, Silicon Schottky diode, Silicon Carbide Schottky diode, MOSFET, Recovery time, switching losses

I. INTRODUCTION

Semiconductor power devices, especially diodes play important role in switching response. Low power dissipation on the switching devices will give rise to highly efficient power electronic system. For example, if a semiconductor device operates in a linear mode such as in power amplifiers of in linear regulators, it is expected that some amount of energy will be lost in the power circuit before its energy reaches the output. High efficiency of power converter requires a minimal loss of this energy from source to load. One of the energy can be easily dissipated in the diodes in terms of heat leading to a lower efficiency of the converter [1]. The unipolar Silicon Schottky (Si) and Silicon carbide Schottky (SiC) diodes are commonly used in power converters circuits. In spite of both diodes come from the same unipolar family, the issues of higher switching losses with regards to reverse recovery losses have yet been solved. Nevertheless, the new SiC diode has emerged in the market in recent years where they are expected to improve the efficiency of the converter by allowing a further reduction in reverse recovery energy losses and hence increasing the performance. The additional substance of carbide element in the power Schottky diode may eventually lower the reverse charge current thus, improve the overall transient response in the converter. An ideal semiconductor device would inhibit large breakdown voltage, low voltage drop in the on-state, high switching speed and low power loss. However in order to increase the performance of a semiconductor device, several additional doping enhancements will be added during the fabrication stage, where the characteristics of the device will altered by adding some impurity atoms to the pure semiconductor material. Today's technology requires extensive research to develop more powerful devices, not only to have lower switching losses, higher efficiency but also improve reliability. For this reason, power losses in the device must be put into consideration. The main contribution in this work is to verify that SiC high power diode having larger energy bandgap can indeed produce better results in DC-DC converter. The analyses are mainly done using circuit simulator.

II. SILICON SCHOTTKY DIODE FAMILY

The Silicon Schottky diode of Schottky barrier diode is widely used as a mixer or detector diode. In addition to its low forward voltage drop, it may lead to lower levels of power losses in the circuit [2]. Since Si diode is a unipolar device, the current transport is mainly due to majority carriers and therefore the speed is faster. In addition, it has low turn-on voltage, high frequency capability and low capacitive effect [3]. SiC diode is a wide-bandgap (WBG) semiconductor family from III-V group. It has the advantages in faster recovery times as well as no dependence on temperature [4] and has the potential to operate more efficiently. In Si diode however, the temperature may rise due to the increasing in electron's thermal energy leading to higher peak reverse recovery current [5]. This eventually gives higher power loss in the device.

In addition to smaller package and higher weight, SiC diodes also have higher critical field and barrier heights compared to Si diode. This results in reduced on-state resistance and lower leakage current or SiC diode [6]. It also has been demonstrated that the SiC diode has the potential to improve power FET performance [7]. Its energy bandgap is three times higher than Si and ten times higher in electrical breakdown strength. Therefore, SiC can operate at operating voltage of 20 times with current densities up to 400 times higher than Si diode [8]. SiC Schottky diode has a small forward voltage and the reverse breakdown voltage cannot be made too high (currently about 200 V). It is used for rectification of power supplies for low voltage and high current applications or in high frequency systems due to its small reverse recovery time.

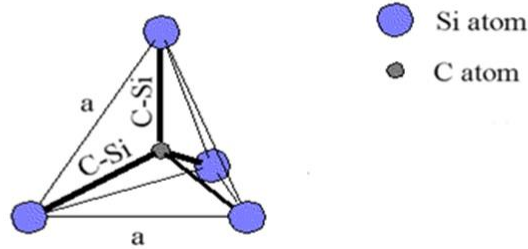

Fig.1 The tetragonal bonding of a carbon atom with the four nearest silicon neighbors. The distance a and C-SiC are approximately 3.08\AA and 1.89\AA respectively.

Fig. 1 shows four Si atoms made a covalent bonding with a single Carbon © atom to form a SiC. The C atom is located in the middle of the structure and the distances between all atoms which marked C-Si are equal. The SiC possess increase tolerance to radiation damage, marking it a material suitable for defense and aerospace applications. Due to high tolerance of temperature in SiC, it is chosen in various industries, such as aircraft, automotive communications, power and power spacecraft.

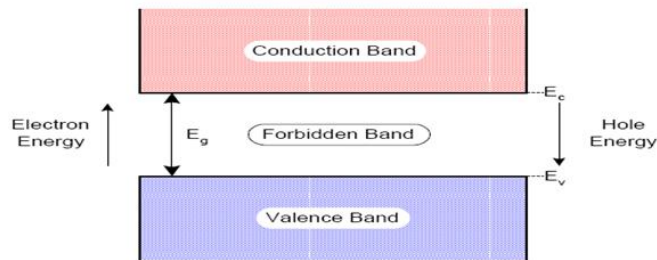

Fig. 2 Energy Band Diagram of a Semiconductor.

The characteristics of SiC diode as a wide bandgap semiconductor device results in a more energy to excite the electron from its covalent bond during turn-off compared to Si. Referring to Fig. 2, the wide bandgap is measured from the distance between the conduction band and valence band. An insulator would have a larger bandgap that would take lots of energy for the electrons to travel from the valence to conduction band while a conductor would have no forbidden band. The energy is calculated from the difference between both bands. The wider the bandgap, more thermal energy is required to excite the electrons enabling the device to operate at higher temperature without affecting its electrical properties.

III. REVERSE RECOVERY

Reverse recovery is one of the properties in a diode. It can be a factor in determining the efficiency of the applications. When a diode has been conducting in a forward bias long enough for it to establish steady, there will be charges due to the presence of minority charge carriers. This charge must be removed to block in reverse direction.

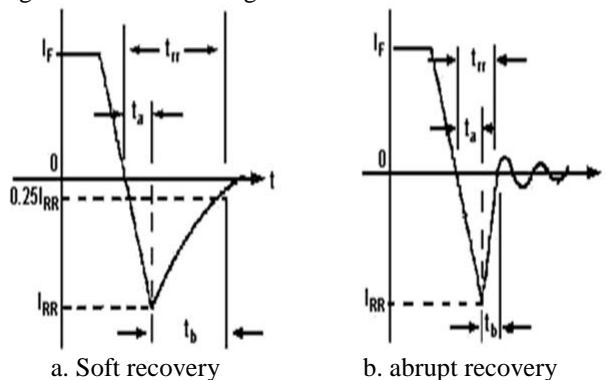

Fig. 3 Reverse Recovery Current Characteristic

The characteristics of reverse recovery current experienced by a diode is represented Fig. 3 above, t_{rr} represents the reverse recovery time, I_{rr} is the peak reverse current whilst t_a is the transition time due to charge stored in depletion region of the p-n junction and t_b is the time for the current to relax to zero. The peak reverse recovery current depends on the falling rate of change in current during turn-off. In SiC diode, there will be less or none reverse recovery current due to its ability to immediately remove stored charge. However, there are differences observed during the recovery from the peak values. This is merely reflected from different device's fabrication techniques.

Normally, in SiC, the rising current rate takes a longer time (t_{rr}) as shown in part (a) in Fig 3. This eventually reduces the turn-off speed. In other SiC type, The speed can also be slightly faster due to smaller t_b but with the cost of higher dissipation. This can be seen in part (b) as oscillation exists during the end stage of turn-off time. In addition, if the falling current rate during the beginning of turn-off time is high as in the case of non-schottky diode, the reverse current would also be high, leading to both high power dissipation and lower in turn-off speed.

IV. DIODE CHARACTERISTICS

4.1 Static Characteristics

The I-V and reverse current are among the static characteristics of the device. Due to higher level of majority carrier injection in Si diode, this causes a lower voltage drop and hence smaller capacitance to bias the junction for turn-on process. This is the only advantages of Si diode compared to SiC. Here, SiC diode requires a higher voltage to forward bias the device. Apart from that, SiC diode can handle larger reverse voltage as compared to Si.

4.2 Dynamic Characteristics

The characteristic that changes with time is inherited in both devices. Si and SiC diodes are compared in terms of the reverse recovery time, reverse recovery current and corresponding switching losses. The comparisons in dynamic characteristics between two devices are tabulated in Table I. The SiC and Si diodes used are of part number UPSC600 and B530C respectively.

Table I. Comparison of Dynamic Characteristics

Characteristics	SiC Schottky (UPSC600)	Si Schottky (B530C)
Reverse Recovery Time	Time Unchanged with temperature variation	Increases as temperature increases
Reverse Recovery Current	Negligible	Increases as temperature increases
Switching Losses	Low	Slightly higher

Table I shows that SiC diode has advantages in all dynamic characteristics. Si diode suffers from higher reverse recovery current and switching losses. This clearly indicates that additional carbide substance in the device may improve switching speed and reduce power dissipation.

V. AC-DC-AC-DC Converter Using SiC

Figure 1 shows the circuit diagram of AC-DC-DC converter (switched mode), the LT spice simulation package is used for simulating this circuit. Table II give the parameters of the active devices used in this circuit simulation. The input 230 V, 50 Hz 1 ϕ sine wave is used. Using MUR460 power diodes (D1-D4), bridge rectifier is constructed and capacitor C2 is connected across bridge rectifier output to reduce the ac component. The switching device M1 (STP8NM60) MOSFET used as switch. The gate pulse of amplitude 7 V with 25 μ sec. on period of 50 μ sec. total period is applied. Gate pulse Vg1is shown in Figure 2 The primary and secondary (diode) currents are shown in Figure 3 and Figure 4 respectively. The load for this circuit is used as resistive load 10 Ω . The laod current for this circuit design is 700 mA with 50 μ sec duration and it is shown in Figure 5 and Figure 6 gives the current through load capacitor. The peak power of the diode is 6.3 W as shown in the Figure7.

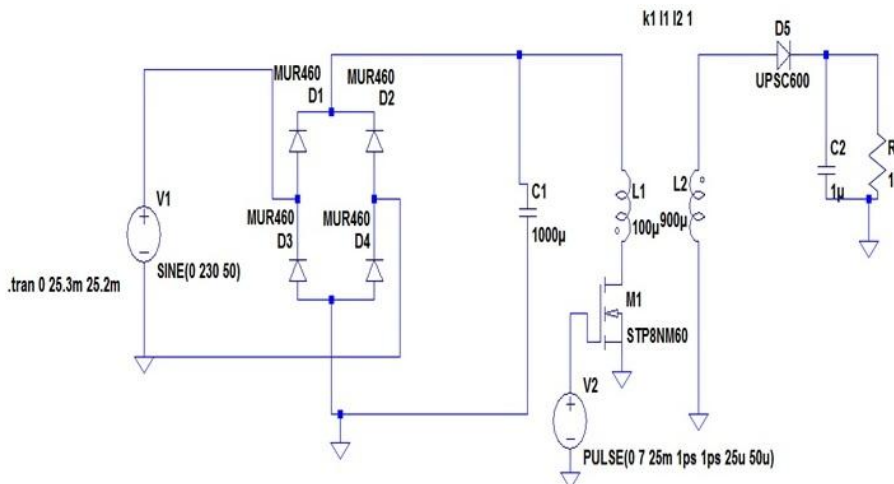

Figure 1 Circuit diagram of AC-DC-AC-DC converter using SiC (Switched mode)

Table II Device parmeters in the test circuit

MOSFET Properties		Diode properties	
MOSFET	STP8NM60		
Manufacturer	STMicroelectronics	Manufacturer	Microsemiconductor
Polarity	N-chan	Type	SiC Schottky
Vds[V]	650	Average forward current[A]	1
Rds[on] Ω	0.9	Breakdown voltage[v]	600
Qgate[C] 1	1.3e.008		

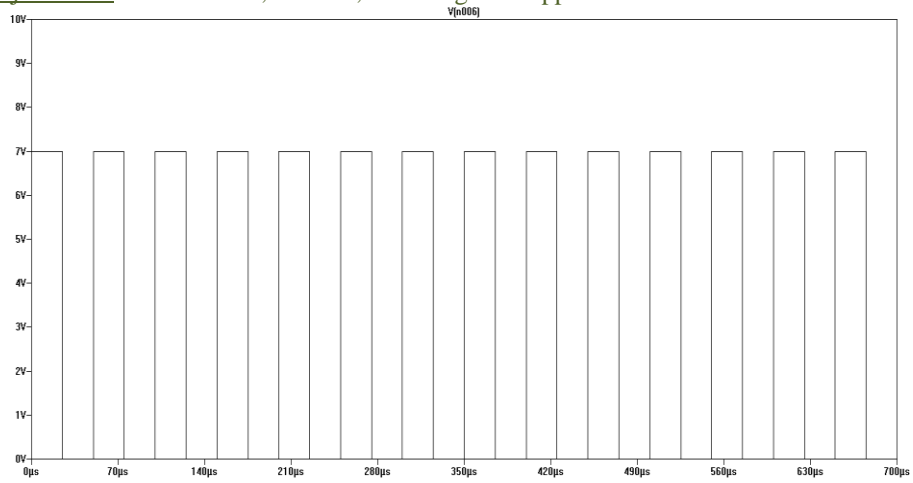

Figure 2 Gate to source voltage (Vgs)

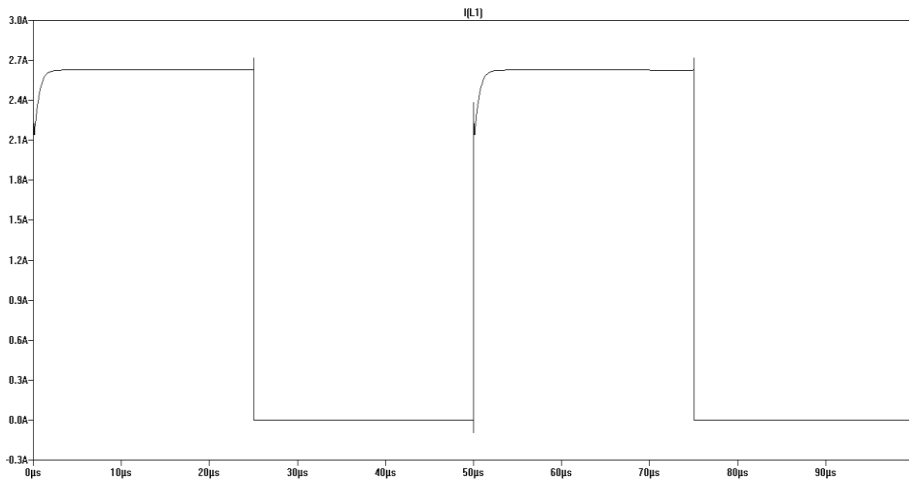

Figure 3 Primary current

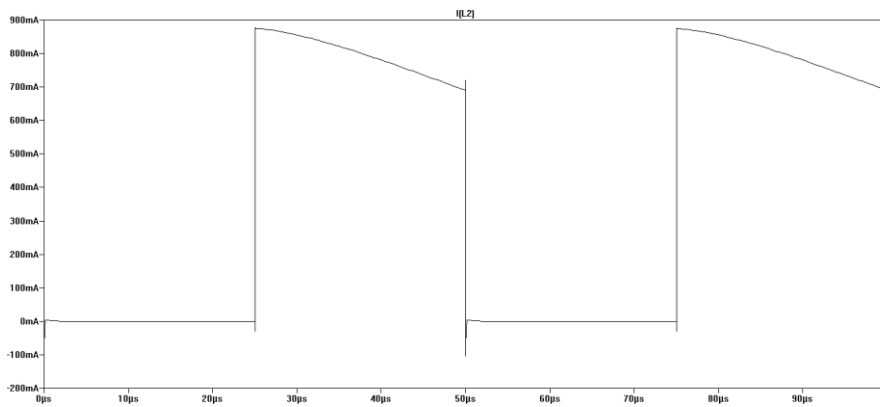

Figure 4 Secondary current (current through diode)

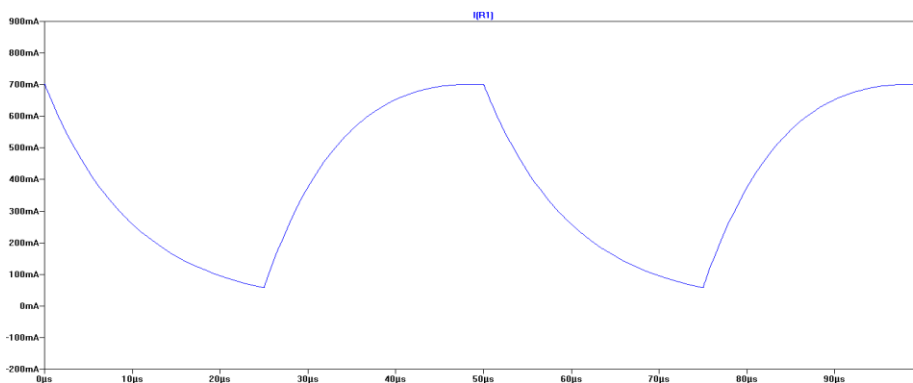

Figure 5 Current through Load Resistor

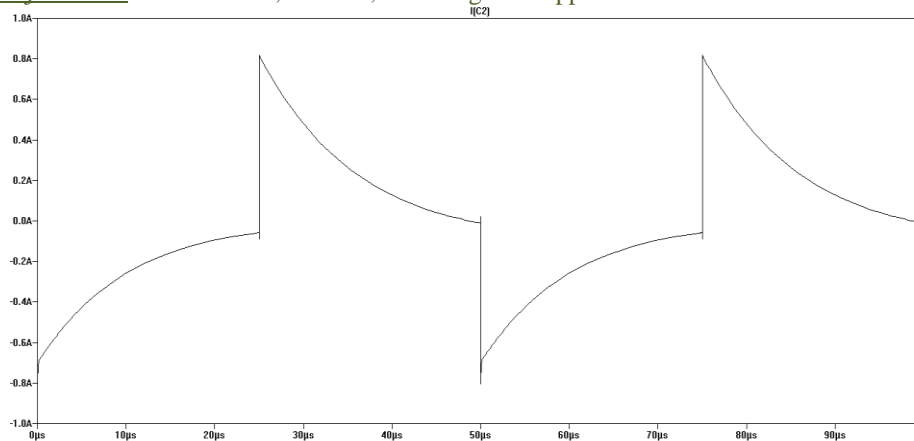

Figure 6 Current through Load Capacitor

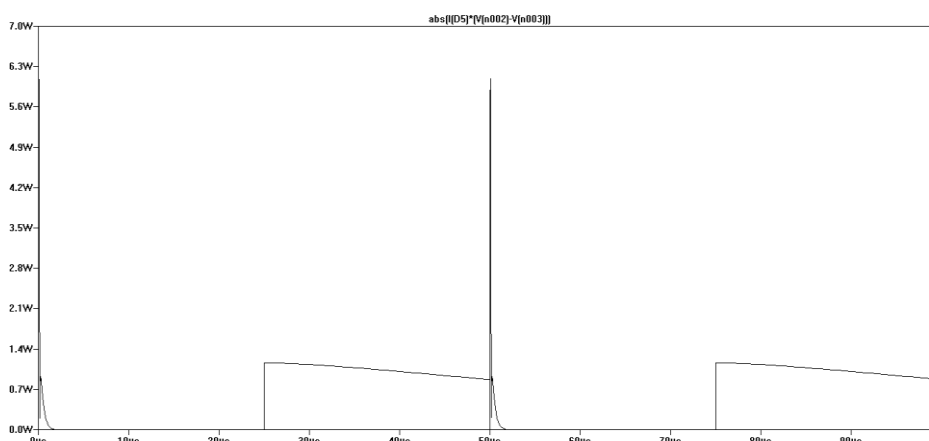

Figure 7 Power in diode

VI. Results and Discussion

The maximum primary current in the circuit is 2.6 and maximum secondary current (through the diode) is 900 mA by simulation using LT spice simulation tool. The maximum current through the load and capacitor is 0.8 A at 25µsec. The switching power loss in the SiC Schottky diode is 6 W. The results are shown in Figures 5.26 to 5.31 and these are simulated characteristics using LT spice simulation tool.

REFERENCES

- [1] I. Batarseh "Power Electronic Circuits", University of Central Florida, John Wiley & Sons, Inc., 2004.
- [2] A.P. Malvino, "Transistor Circuit Approximation", McGraw-Hill, Inc., 3rd Ed., 2007
- [3] F. Mohammed, M.F. Bain, F.H. Ruddell, D. Linton, H.S. Gamble and V.F. Fusco, "A Novel Silicon Schottky Diode for NLTL Applications", *IEEE Transactions on Electron Devices*, vol. 52, iss. 7, pp. 1384-1391, July. 2005.
- [4] B. Ozpineci and L.M. Tolbert, "Characterization of SiC Schottky Diodes at Different Temperatures", *IEEE Power Electronics Letters*, vol. 1, no. 2, pp. 54-57, Jun. 2003.
- [5] M.S. Chinthavali, B. Ozpineci and L.M. Tolbert, "Temperature-Dependent Characterization of SiC Power Electronic Devices", *IEEE Power Electronic in Transportations*, pp. 43-47, Oct. 2004.
- [6] M.J. Kearney, M.J. Kelly, A. Condie and L. Dale, "Temperature Dependent Barrier Heights in Bulk Unipolar Diodes Leading to Improved Temperature Stable Performance", *IEEE Electronic Letters*, vol. 26, iss. 10, pp. 671-672, May 1990.
- [7] B.J. Baliga, "Power Semiconductor Device Figure of Merit for High-Frequency[8] Purdue University Nanoscale Center, Wide Bandgap Semiconductor Devices. Applications", *IEEE Electron Device Letters*, vol. 10, iss. 10, pp. 455-457, Oct. 1989.
- [8] Purdue University Nanoscale Center, Wide Bandgap Semiconductor Devices.

ACKNOWLEDGMENT

The authors are grateful for the support and encouragement of Dr. M. N. Channabasappa, Director, and Dr. Shivkumaraiah, Principal of Siddaganga Institute of Technology, Tumkur.

BIOGRAPHIES



Y. S. Ravikumar received B. E degree from Bangalore University in 1981 and M.S. Degree from BITS, Pilani in 1985 Since 1983 he had been with Electronics and Communication Engineering Department, SIT, Tumkur. At present he is an Associate Professor in the Department of Telecommunication Engineering, SIT, Tumkur. His research interests are in SiC device and electronics technology, and power electronics devices. He has two international conference papers and four publications to his credit.