

Retrofitting and Strengthening of Damaged Reinforced Concrete Columns Using Steel Angles Wrapped with Steel Wire Mesh

Abd-ELhamed, M. K.¹, EZZ-Eldeen, H. A.²
1 and 2 Faculty of Engineering, Al – Azhar University, Cairo, Egypt

ABSTRACT: Six reinforced concrete rectangular columns with a cross section 120x160 mm and 800 mm length were casted and tested until failure. Two control columns were tested under axial load and four columns were tested under different eccentricities $e/t = (6.30\%, 12.5\%, 18.75\% \text{ and } 25\%)$. All specimens were retrofitted by replacing the loose concrete part by grout mortar. Strengthening was carried out using four vertical steel angles, two angles 30x30x3mm in eccentricity direction and two angles 15x15x3 mm in the reverse direction all wrapped with expanded three plies steel wire mesh. However, the steel wire mesh jacket was injected by cement mortar. The test results showed that columns strengthened with four vertical steel angles wrapped with three plies steel wire mesh tested under different eccentricity recorded a higher failure load than that wrapped with three plies steel wire mesh only. The increase in column carrying capacity ranged from 102.5% to 112%.

Keywords: Column; Eccentricity; Retrofitting; Strengthened; Jacket; Wire mesh;

I. Introduction

A large number of reinforced concrete columns have been damaged by earthquakes or as a result of deficiencies in the design. The demand for retrofitting and strengthening of columns has stimulated the development of many different systems for external confinement. The selection of a specific retrofitting and strengthening system depends on the structural performance and economic importance factors for structural. Retrofitting RC columns may be defined as an attempt to restore the original strength and stiffness of damaged as well as deteriorated RC columns. Josh L. Ramirez (1996) performed ten repair methods for RC columns to identify the advantages and limitations of the various strengthening methods. The methods presented were divided into two groups. The first deals with the strengthening of the entire column height, while the second focuses on the problem of damage and loss of strength on a localized section. The comparison showed that the first six methods that extend along the entire column height, in terms of efficiency and cost, appear to be the simple concrete jacket and the steel angle method. The simple concrete jacket is easy to construct and transmission of load is direct. Ghobarah A. and et al (1997) conducted an experimental investigation to study the failure mode of existing reinforced concrete columns designed during the 1960s. Three large-scale columns were strengthened with corrugated steel jacket and tested under cyclic loading. The variable in the test specimens include the amount of column transverse reinforcement and jacketing of the column. The corrugated jacket was found to be effective in the rehabilitation of the selected existing structure. Julio E. S. and et al (2003) evaluated the retrofitting techniques of reinforced concrete columns according that different characteristics. Julio E. S. and et al conducted that the reinforced concrete jacketing strengthening method, unlike other techniques, leads to a uniformly distributed increase in strength and stiffness of columns. Ozcan O. and et al (2007) investigated the structural behavior of undamaged and moderately damaged columns, which were retrofitted with carbon fiber reinforced polymers (CFRP). The experimental program consists of four specimens having inadequate tie spacing 90 degree hooks and plain reinforcing bars that were tested under lateral cyclic displacement excursions under a constant axial load of approximately 27% of the axial load carrying capacity. One control specimen without any strengthening and another specimen with strengthening but without any pre-damage were tested. In one of the pre-damaged columns the repairing process was performed in the presence of constant axial load. The main parameters investigated in this study were the presence of axial load on the column during repairing, the effect of pre-damage on ultimate displacements and the effect of CFRP wrapping on strengthened and repaired columns. LIU Tao and et al (2008) presented a new retrofit method, which utilized fiber-reinforced plastics (FRP) confinement mechanism and anchorage of embedded bars. Carbon FRP (CFRP) sheets and glass FRP (GFRP) bars were used in this test. Five scaled RC columns were tested to examine the function of this new method for improving the ductility of columns. Responses of columns were examined before and after being retrofitted. The test results showed indicate that this new composite method can be effective to improve the anti-seismic behavior of non-ductile RC columns compared with normal CFRP sheets retrofitted column.

Adnan S. AL-Kuaity (2010) tested three groups of reinforced concrete squared tied columns reinforced with 2% longitudinal steel reinforcement ratio. Adnan measured the behavior of repaired by strain on the concrete surface under axial load up to cracking load. The test results showed that the strength of the failed column can be restored by replacing the cracked shell with new shell having high compressive strength. The strength of columns repaired by these materials can reach up to 136% of their original strength depending on both the compressive strength and the condition of pre loading. Ruili H. and et al (2013) used experimental five large-scale severely damaged square RC columns with the same geometry and material properties but with different damage conditions. Each column was repaired and retested under the same loading combination as the corresponding original column. Quickset repair mortar was used to replace the removed loose concrete. Without any treatment to damaged reinforcing bars, longitudinal and transverse CFRP sheets were externally bonded to the prepared surface to restore the column strength. Measured data were analyzed to investigate the performance of the repaired columns compared to the corresponding original column responses. It was concluded that the technique could be successful for severely damaged columns with damage to the concrete and transverse reinforcement. Ruili H. and et al (2014) evaluated a method for repairing severely damaged RC columns subjected to torsional moment using externally bonded carbon fiber-reinforced polymer (CFRP) composites. A half-scale RC column that was previously tested to failure under constant axial load and cyclic torsional moment was repaired with externally bonded CFRP. The results showed that this method can be used to restore the torsional performance of severely damaged RC columns. Contributions of the transverse and longitudinal CFRP sheets to the torsional resistance are evaluated, and repair design for torsional moment using this method is discussed. Elsamny, M.K. and et al (2014) presented a thirty seven specimens tested under different eccentricities from $e/t = 0\%$ up to 25% divided it into three groups. Group one consisted of five specimens tested under different eccentricity as control columns. Group two consisted of sixteen specimens were strengthened with different numbers of steel wire mesh plies (2, 3, 4 and 6). Group three consisted of sixteen specimens were strengthened with a sandwich made of different numbers of steel wire mesh plies (2,3,4,6) and external vertical steel bars $3\text{Ø}8$ in compression side. The test results showed that using wire mesh jacketing technique gives an increase in the load carrying capacity up to 23% . However, using sandwich wrapping system technique which made of steel wire mesh and external vertical steel bars in compression side gives an increase in the load carrying capacity up to 54% . However, the majority of strengthening techniques used GFRP and CFRP are very expensive. Thus, there is an urgent need for the development of improved, lower cost and less disruptive techniques which will make necessary interventions in many structures economically viable.

II. Proposed The Techniques Of Retrofitting And Strengthening

In this investigation the proposed techniques was replacing the loose concrete part by using grout mortar to retrofitting the damage of columns. In additions, two different techniques were used to strengthen the columns as follows:

- Wrapped columns with only three plies expanded steel wire mesh wrapped with two steel straps 30×3 mm at the column top and bottom.
- Four vertical steel angles were used at the corners of column wrapped with three plies expanded steel wire mesh. Two angles $30 \times 30 \times 3$ mm were placed in eccentricity direction and two angles $15 \times 15 \times 3$ mm were placed in the reverse direction as shown in figure 1.

III. Experimental Program And Testing Procedure

Six reinforced concrete columns having a cross section of (120×160) mm and a length of (800) mm were tested until failure as shown in table 1. All specimens contain four longitudinal reinforcement bars 8 mm diameter and stirrups 6 mm diameter bars at spacing of 150 mm. Strain gauges were mounted on the vertical steel bars as well as the external vertical steel angles on the compression side as shown in figures 1, 2. Two specimens were tested until failure under centric loads $e/t = 0$ and the other four specimens were tested until failure under different eccentricity $e/t = 6.3, 12.6, 18.8$ and 25% . Figure 3 shows all specimens after casting and tested until failure before retrofitting. Total removed of damaged parts were replaced by grout mortar.

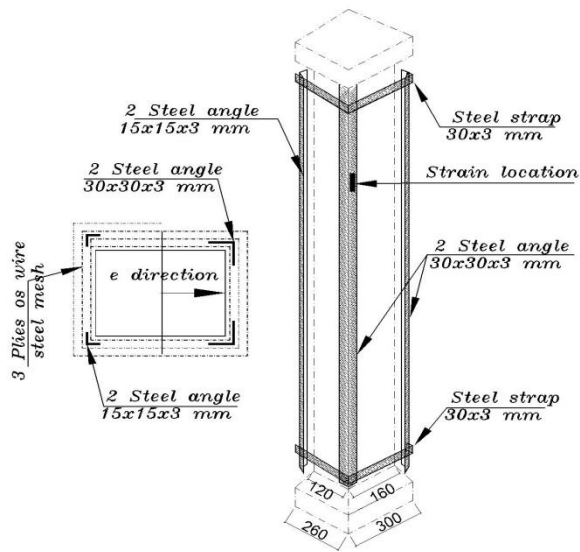

Figure 1 specimens and strengthened details

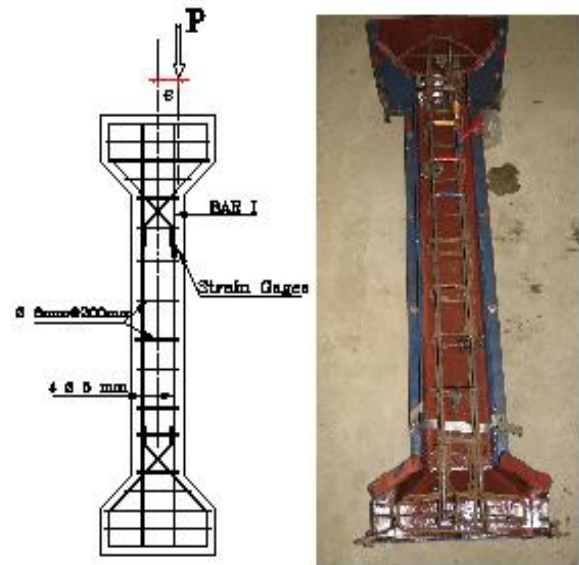

Figure 2 Reinforcement details and strain gages location



Figure 3 Specimens after testing before retrofitting.



Figure 4 Details of retrofitting columns with Grout mortar.

The Cetorex grout mortar with high-strength, low or non-shrink is used for replacing the damaged concrete part and restore specimens dimension as shown in figure 4. Special attention was made to achieving a good bond between the new and the existing concrete. The specimens were cured with wet sackcloth for seven days. One of the specimen was strengthened with three plies steel wire mesh only and tested under eccentricity $e/t= 0$. In addition, one specimen was strengthened with four vertical steel angles 30x30x3mm at each column corners after the column wrapped with one plie steel wire mesh and then wrapped with two plies steel wire mesh as shown in figure 5 and then tested under eccentricity $e/t= 0$. The other four specimens were wrapped with one plie steel wire mesh then placing the vertical steel angles in each column corners and then wrapped with two plies of steel wire mesh. Two angles 30x30x3mm were placed in the eccentricity direction and other two angles 15x15x3mm were placed in the reverse direction. All specimens were wrapped with two steel straps 30x3 mm at the column top and bottom. The Strain Gauges were mounted on the vertical steel angle in the compression side. Thereafter, all the specimens were plastered with rich mix mortar cement sand ratio of 1:2.5 with water-cement ratio = 0.55 as shown in figure 6. In order to improve workability, super plasticizer was used. All columns were cured for 28 days from the date of casting of jacketing. All casted specimens were kept in a dry place for a few hours for attaining surface dry condition. Thereafter, all columns were tested using hydraulic compression testing machine of capacity 2000 KN at the Material laboratory of Al-Azhar University as shown in figure 7. The different eccentricities were controlled by column head steel plates as shown in figure 8.

IV. Used Materials

- The concrete mix was designed according to the Egyptian code of practice to obtain target strength of 25 N/mm² at the age of 28 days.
- The used steel reinforcement was normal mild steel St24/37-smooth rebar of 6 and 8 mm diameter. Tension tests were performed on the steel specimens using Shimadzu 500-KN universal testing machine according to the Egyptian Standard Specifications ESS 262-1999.
- Using cetorex grout mortar which is a cementations mix requiring only the addition of water to produce high strength non-shrink mortar.
- The used galvanized welded steel wire mesh has a specification 12.7x12.7 mm panel size and 1.6 mm wire diameter.
- The used steel angles have a yield stress of 325 N/mm² and tensile strength of 420 N/mm² with an elongation percentage of 30%.
- The used strain gauges were manufactured by KYOWA electronic instrument co, ltd. the type used was kfg-5-120-c7-11 11m2r, which has a resistance of $119.6 \pm 0.4\%$ ohms at 24°C, and a gage factor of $2.1 \pm 1.0\%$.



Figure 5 Details of strengthened column with 4 angles and 3 plies wire mesh



Figure 6 Form shape used for cement mortar



Figure 7 Test machine and test setup

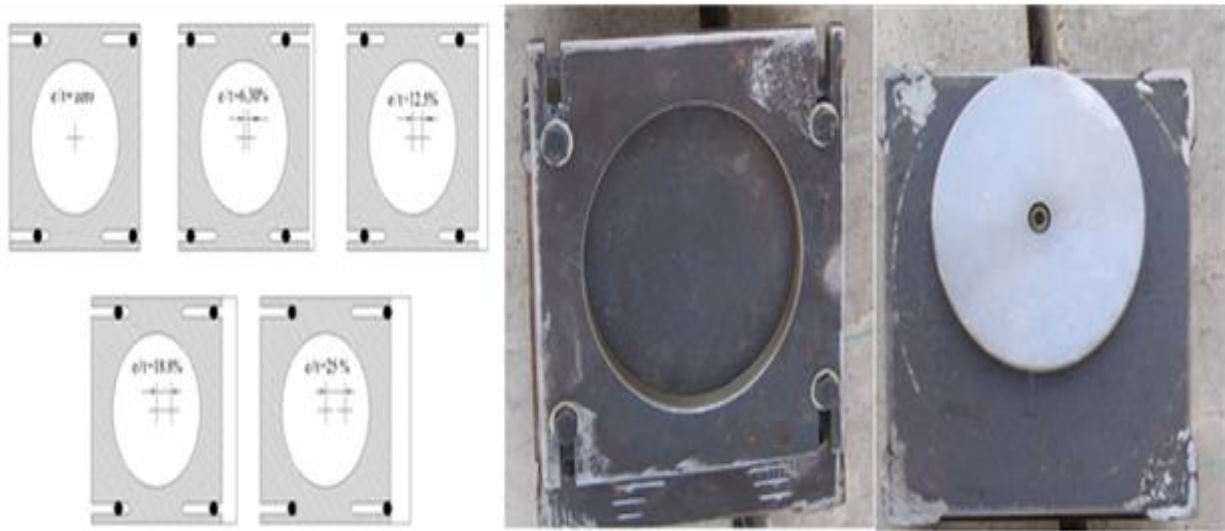

Figure 8 Column head was used to applied eccentricity

V. Experimental Test Results

The obtained results are discussed as follows:

1. Test Results of Control Columns (non-Strengthened Columns)

- Table 1 shows the maximum failure load of columns (control columns) and the percentage decrease in ultimate column capacity due to different eccentricities $e/t=$ (0% to 25%). The increase in eccentricity from $e/t=$ 0% to 25% decreases the ultimate load carrying capacity by 93% to 71% from column carrying capacity $e/t=0$.

Figure 9 shows the relationship between the load and longitudinal strain. For the internal vertical steel bar in the eccentricity direction BAR I (no retrofitting and no strengthened) Due to increasing eccentricity, the strain in BAR I increases from 820micro strain to 1500 micro strain while the load decreased from 541 KN to 385 KN.

2. Test Results of Strengthened Columns

- Table 2 shows the maximum failure load of columns (Strengthened Columns)and the percentage decrease in ultimate column capacity due to different eccentricities $e/t=$ (0% to 25%). The increase in eccentricity from $e/t=$ 0% to 25% decreases the ultimate load carrying capacity by 112% to 102.5% from column carrying capacity $e/t=0$.
- Figure 10 shows the relationship between the load and longitudinal strain. For the internal vertical steel bar in the eccentricity direction BAR I (after retrofitting and strengthened with 4angles&3 plies wire mesh) Due to increasing eccentricity, the strain in BAR I increases from 1100micro strain to 2100 micro strain while the load decreased from 608 KN to 555 KN.
- Figure 11 shows the load-strain relationship between the load and longitudinal strain. For the external vertical steel angles in the eccentricity direction (after retrofitting and strengthened with 4angles&3 plies wire mesh) Due to eccentricity, the strain in the external angles increases from 400micro strain to 1500 micro strain while the load decreased from 608 KN to 555 KN.

Table 1 Failure loads of control columns

Specimen name	e/t %	Specimen description	Failure loads KN	% of Column carrying capacity from $e/t=0$
C ₀	0	Control column	545	--
C ₁	0	Control column	541	100%
C ₂	6.3	Control column	505	93%
C ₃	12.6	Control column	487	90%
C ₄	18.8	Control column	423	78%
C ₅	25	Control column	385	71%

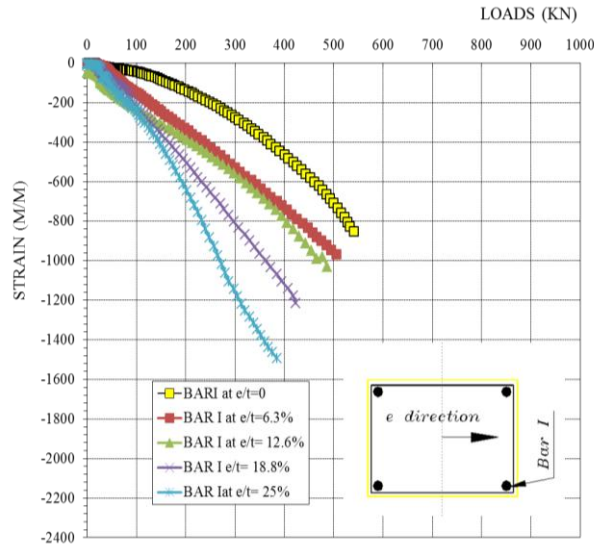

Figure 9: The relationship between load and longitudinal strain for Bar I at $e/t= 0\%$ to 25% (Control Column-non strengthened)

Table 2 Failure loads of strengthened columns

Specimen name	e/t %	Specimen description	Failure loads KN	% of Column carrying capacity from $e/t=0$
C0 _R	0	Strengthened with 3 plies wire mesh	490	89%
C1 _R	0	Strengthened with 4angles&3 plies wire mesh	608	112%
C2 _R	6.3	Strengthened with 4angles&3 plies wire mesh	587	108.5%
C3 _R	12.6	Strengthened with 4angles&3 plies wire mesh	571	105.5%
C4 _R	18.8	Strengthened with 4angles&3 plies wire mesh	567	104.8%
C5 _R	25	Strengthened with 4angles&3 plies wire mesh	555	102.5%

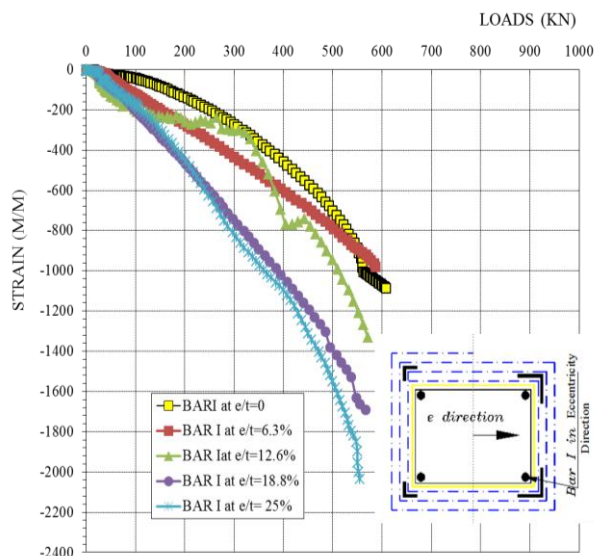

Figure 10: The relationship between load and longitudinal strain for Bar I at $e/t= 0\%$ to 25% (4angles&3 plies wire mesh)

- Table 3 shows the values of the forces in the vertical steel bars in the eccentricity direction BAR I as well as the vertical steel angles. The shown values were obtained by converting the strain values to the forces taken the modulus of elasticity of steel bars equal 210 KN/m² and cross-sectional area of longitudinal reinforcement bars is 50.29 mm² per one 8mm diameter bar. Also, the cross-sectional area of vertical steel angles 174mm² per one angle 30x30x3.
- Figure 12 shows the relationship between the forces in a vertical steel BAR I (before and after strengthened) as well as steel angles with respect to control column at failure loads and increasing eccentricity from e/t= (0% to 25%). The percentage of forces in the steel bars at the eccentricity direction increased from 4% to 8.2 % of the failure load with eccentricity increased from e/t= 0% to 25% in case of control columns. However, the percentage of forces on the bar at eccentricity direction increased from 3.8% to 7.8 % of the failure load with eccentricity increased from e/t= 0% to 25% in case of strengthened columns. The percentage of forces in the vertical steel angles used in the strengthening techniques found to be in the range of 5.2% to 20 % of the failure load.
- Figure 13 shows the relationship between percentage column load carrying capacity control (e/t=0) and percentage of eccentricity for (control and strengthened columns). The column strengthened with three plies steel wire mesh only could not reach the ultimate loads of control column. The ultimate load of column was found to be 89% of the original ultimate load. The columns strengthened with four steel angles and wrapped with three plies steel wire mesh gives an increase in the load carrying capacity from 102.5% up to 112%.
- Figure 14 shows the failure mode of columns under different eccentricities. The failure mode of the control reinforced concrete columns was brittle failure while strengthening with steel wire mesh jacket changed failure mode to be ductile.

Table 3: Forces in a vertical steel bar I and steel angle with respect to control column at failure loads due to increasing eccentricity

Specimen name	e/t%	Failure loads KN	%force in BAR I / failure load KN	% Force in angle / failure load KN
C1	0	541	3.32%	
C2	6.3	505	4.06%	
C3	12.6	487	4.47%	
C4	18.8	423	6.07%	
C5	25	385	8.20%	
C1R	0	608	3.78%	5.14%
C2R	6.3	587	3.52%	13.57%
C3R	12.6	571	4.93%	17.84%
C4R	18.8	567	6.30%	17.41%
C5R	25	555	7.74%	19.89%

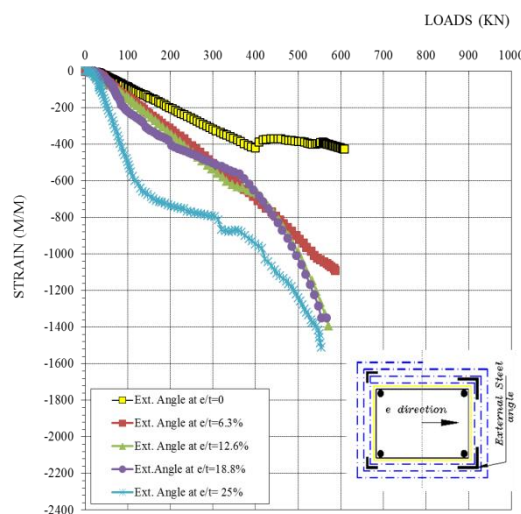

Figure 11: The relationship between load and longitudinal strain for angle at e/t= 0% to 25% (4angles&3 plies wire mesh)

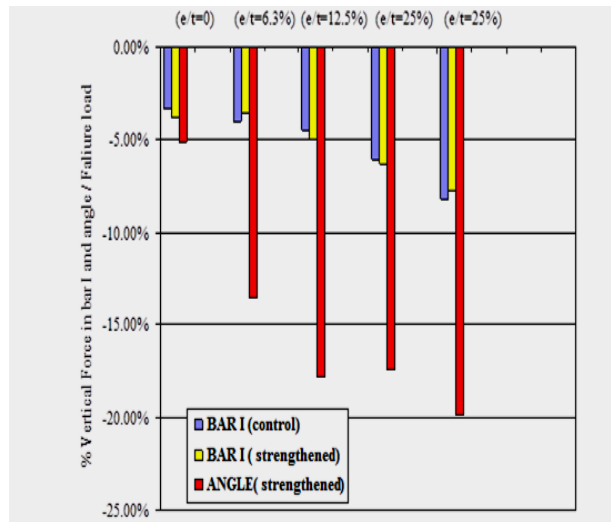

Figure 12: The relationship between forces in a vertical steel bar I and steel angle with respect to control column at failure loads

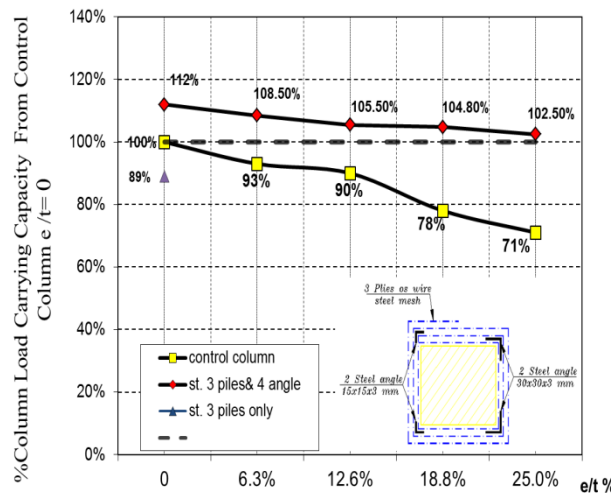

Figure 13: The relationship between % column load carrying capacity of control ($e=0$) and percentage of eccentricity for (control and strengthened column)



Figure 14: Failure Modes of Strengthened Columns

VI. Conclusions

The used retrofitting and strengthening technique is successful for damaged columns to improve the load carrying capacity under to eccentric loads. From the experimental results the followings are concluded:

- The increase in eccentricity from $e/t= 0\%$ to 25% decreases the ultimate load carrying capacity of columns by 93% to 71% from column carrying capacity $e/t=0$.
- The percentage of forces on the internal vertical steel bars at eccentricity direction decreases about 5% while the strain increases about 25% .
- The columns strengthened with four vertical steel angles at the corners wrapped with three plies steel wire mesh recorded a higher failure load than that strengthened with three plies steel wire mesh only.
- The columns strengthened with four steel angles and wrapped with three plies steel wire mesh give an increase in the load carrying capacity from 102.5% up to 112% .
- Columns retrofitted with grout mortar and strengthened with four steel angles wrapped with three plies steel wire mesh were found to be very effective for to improving the ultimate capacity as well as the ductility of columns.
- The number of plies is the recommended to be not less than three plies. In additions, the area of the vertical steel angles in the reverse direction is recommended to be not less than 50% of the area of vertical steel angel in eccentricity direction.

ACKNOWLEDGEMENT

May all praise and thanks (first and last) be to ALLAH, the almighty, with whose gracious help it was possible to accomplish this work. Deep thanks and appreciation are also due Prof. Mohamed Kassem EL Samny for his Permanent to encourage him to move forward in scientific research

REFERENCES

- [1] Adnan S. AL-Kuaity (2010); "Rehabilitation of Damage Reinforced Concrete Columns" Al-Qadisiya Journal For Engineering Sciences Vol.3, No.1, Year 2010.
- [2] Elsamny, M.K., Abd-Elhamed, M.K, Ezz-Eldeen, H.A. and Elmokrany, A.A. (2014), "Strengthening of Eccentrically Loaded Rectangular Reinforced Concrete Columns Using Steel wire Mesh" Civil Engineering Research Magazine (CERM) Civil Engineering Department, Faculty Of Engineering, Al-Azhar University, accepted for publication.
- [3] Ghobarah A., Biddah A. and mahgoub M. (1997) "Rehabilitation of Reinforced Concrete Columns Using Corrugated Steel Jacketing" Journal of Earthquake Engineering Volume 1, Issue 4, pages 651-673, year 1997
- [4] Julio E. S., Branco F. and Silva V. D. (2003) "Structural Rehabilitation of Columns with Reinforced Concrete Jacketing" Prog. Struct. Engng Mater. Vol. 5, pp.29-37, (year 2003).
- [5] LIU Tao, FENGWei, ZHANG Zhi-mei and OUYANG Yu(2008) " Experimental Study on Ductility Improvement of Reinforced Concrete Rectangular Columns Retrofitted with a New Fiber Reinforced Plastics Method" J Shanghai University (Engl Ed) vol.12(1), pp. 7-14, (year 2008).
- [6] Ozcan O., Binici B. and Ozcebe G. (2007); " Seismic retrofitting of Reinforced Concrete Columns Using Carbon Fiber Reinforced Polymer (CFRP)" Asia-Pacific Conference on FRP in Structures (APFIS 2007).
- [7] Ramirez Josh L. (1996) "Ten Concrete Column Repair Methods" Construction and Building Materials, Vol. 10, No. 3, pp. 195-202, year 1996.
- [8] Ruili H., Lesley H. S., and Abdeldjelil B. (2014) " Torsional Repair of Severely Damaged Column Using Carbon Fiber-Reinforced Polymer" ACI Structural Journal, Vol. 111, No. 3, May-June 2014.
- [9] Ruili He., Lesley H. Sneed, and A. Belarbi (2013); "Rapid Repair of Severely Damaged RC Columns with Different Damage Conditions: An Experimental Study" International Journal of Concrete Structures and Materials Vol.7, No.1, pp.35-50, March 2013.