

# Multiband and Modified Time Based Hysteresis Current Controller for Single Phase Multilevel Inverters

Tamilselvan R<sup>1</sup>, Padmathilagam V<sup>2</sup>

<sup>1</sup>Department of Electrical Engineering, Annamalai University, India

<sup>2</sup>Department of Electrical Engineering, Annamalai University, India

**ABSTRACT:** The unmatched dynamic response and wide command-tracking bandwidth of the hysteresis modulation for power electronic converters has been utilized in many power electronics application. The application of hysteresis modulation and the benefits of hysteresis modulation for two-level converters are well known, but the implementation and analysis of this approach to multilevel converters is still under progress. In this paper, the different hysteresis modulation approaches, multiband and time based approach are implemented for a single phase multilevel converters. The procedure and connections of the proposed techniques are described and compared for tracking the reference signal in order to achieve an optimum switching action, better dynamic behavior and high precision. By using the proposed multilevel hysteresis modulation approaches, the advantages of using numerous available dc potentials in a multilevel inverter have been fully exploited. These hysteresis modulation approaches have been tested for tracking a current reference when applied to a five-level inverter. The corresponding simulation results are presented. This paper provides an useful outline and serves as a reference for the future expansion of hysteresis modulation for different multilevel converters.

**Keywords:** Multilevel Inverters, Multiband, Time based, Hysteresis Current control.

## I. INTRODUCTION

Power electronics circuits are intended to control the flow of electrical energy in a circuit. The power flows in the power electronic circuits in much higher than the individual device rating. Power electronics is positioned on a stage with digital, analog, and radio-frequency electronics because of its unique design methods and challenges. There is an exponential growth in the expansion of applications of power electronics. Power electronics are also utilized in operation of alternative energy systems such as wind generators, solar power, fuel cells. Other advanced technologies such as hybrid electric vehicles, laptop, computers, microwave ovens, flat-panel displays, LED lighting, and hundreds of other innovations also uses advances in power. The term “converter system” in general is used to denote a static device that converts AC to DC, DC to AC, DC to DC or AC to AC. The static power converters produce an AC output waveform from the available DC power supply. These waveforms are necessary for variable Speed Drives, Uninterruptible Power Supplies (UPSs), static VAR compensators, active filters, Flexible AC Transmission Systems (FACTSs) [1] and voltage compensators, etc.. The magnitude of the AC output, frequency of the AC output and its phase angle should be controlled for optimum results.

## II. Multilevel Inverter

The Multi Level Inverters (MLI) has attained tremendous attention in the field of power industry. The Multi Level Inverters are appropriate for reactive power compensation [2-4]. The power rating can be increased by increasing the number of voltage levels in the inverter without any need of higher ratings on individual devices. Without the use of transformers or series connected synchronized switching devices, the structure of multilevel voltage source inverters enables them to attain high voltages with low harmonics. The harmonics present in the output voltage waveform reduces considerably with the increase in voltage levels [5].

The Multi Level Inverter (MLI) synthesizes a near sinusoidal voltage from several DC voltage sources. With the increase in number of levels, the synthesized output will result with more steps, which approaches the preferred sinusoidal waveform. With increased levels, the output voltage also increases that can be spanned by summing multiple voltage levels. MLIs have many attractive features like high voltage capability, reduced common mode voltages, near sinusoidal outputs, low dv/dt and smaller or even no output filter, making the inverters suitable for high power applications.

### III. Hysteresis Controller

As the number of levels increases, the Total Harmonic Distortion (THD) will decrease. An output voltage with desirable low THD is possible by increasing the number of levels but this requires more hardware, making the control more complicated. It is an optimum process evolving price, weight, complexity and an efficient output voltage with lower THD [6-10]. Because of the simplicity and ease of implementation, the hysteresis band current control is often preferred. This method does not require any knowledge of load parameters. In the current control with hysteresis band, the PWM frequency changes inside a band as peak to peak current ripple is necessary to be controlled at all points of the fundamental frequency wave.

The realization of hysteresis current control is related with on obtaining the switching signals from the evaluation of the current error with an acceptance band. The hysteresis current control is depended on the comparison of the actual phase current with the acceptance band about the reference current linked with that phase.

$$\text{If } (ce(t) \geq +h) , \text{ then } u(t) = -1 \quad (1)$$

$$\text{else if } (ce(t) \leq -h) , \text{ then } u(t) = +1 \quad (2)$$

Here “h” is a suitable hysteresis band, for which the size is obtained by the maximum permissible switching frequency of the switching devices, and the maximum permitted level of current distortion. A hysteresis controller with low “h” value will result in increased switching actions, hereafter, increased switching losses. But for a hysteresis controller with large value of “h” will have increased distortion in the controlled current. Therefore, a trade off is always required in designing the hysteresis band size.

### IV. Principle of Hysteresis Modulation

In hysteresis modulation [11], the current follows the reference current contained by a hysteresis band. The waveform for principle of the hysteresis modulation is shown in Figure1. The reference current with preferred magnitude and frequency generated by the controller is compared with the actual line current. As the current crosses the upper limit, the upper switch of the inverter arm is turned off and at the same instant the lower switch of the inverter arm gets turned on. This results in decaying of current. As the current goes below the lower limit, the lower switch of the inverter arm gets turned off, consequently the upper switch of the inverter arm is tuned on. Due to this, the current is contained within the hysteresis band limit. This forces the actual current to track the reference current inside the hysteresis band limit.

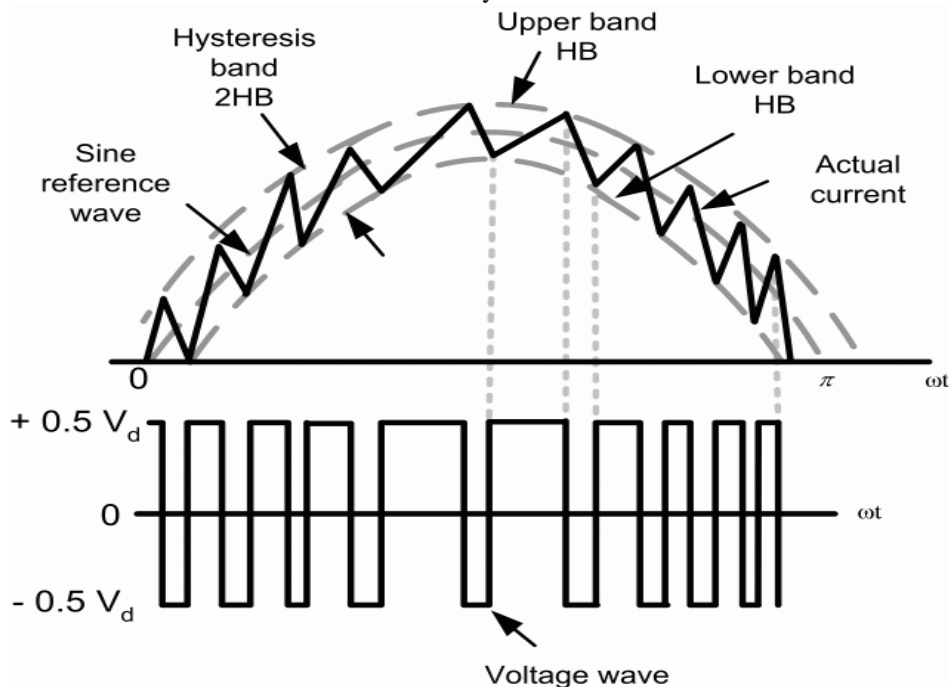

Figure 1: Principle of Hysteresis Modulation and its waveform

### V. Hysteresis Current Controller

For all the applications, the hysteresis current control technique [12-14] has been established to be an acceptable solution such as active filters, drives and high-performance AC power conditioners. The conventional hysteresis current control technique is affected by the drawback of a variable switching frequency. Various strategies have been reported to obtain fixed switching frequency, based on feed forward compensation, the current error zero crossing, equidistant-band, switching time prediction. Many of these strategies can be only applicable only to single/ three phase systems, or three-level inverters. Up to now, many of hysteresis control strategies for multi-level inverters have been modified to improve system performance, but at the expense of different switching frequency. In this paper, a variable hysteresis control method for implementing multilevel modulation of Multi Level Inverters with constant switching frequency, by using the Multi Band and Modified Time Based Hysteresis Modulation technique have been presented. The control technique offers all the advantages of current Hysteresis control in terms of reference tracking, robustness, rapidly dynamic response, fixed switching frequency, and can easily be adapted to control multilevel inverters of any topology.

### VI. Multiband Hysteresis Modulation

In Multi Band Hysteresis Modulation method [15], the multilevel converters utilizes symmetrical hysteresis bands to organize the switching such that the internal band causes switching among adjoining levels, while the external band causes an additional switching level to transform when required. As the value of error in current crosses the inside boundary B, the output of inverter is either decreased or increased by one level. The increase or decrease of level depends on the hysteresis boundary that has been crossed. Actually, this change in voltage makes the current error to overturn its direction without attainment of the subsequent outer band. If the current error value does not overturn, it will persist throughout the boundary of B to the subsequent external boundary which is positioned at  $\Delta B$  from B. During this instant, subsequent upper or lower level voltage will be switched. This process continues until the current error direction reverses. If the level of voltage applied at the crossing limit of the current error is inadequate to force the error back, then again no voltage level is applied as the error again crosses this limit next time after the earlier voltage level change with the similar slope. The error in that case is permitted until the next voltage level change at next higher or lower boundary crossing of the error to force it back.

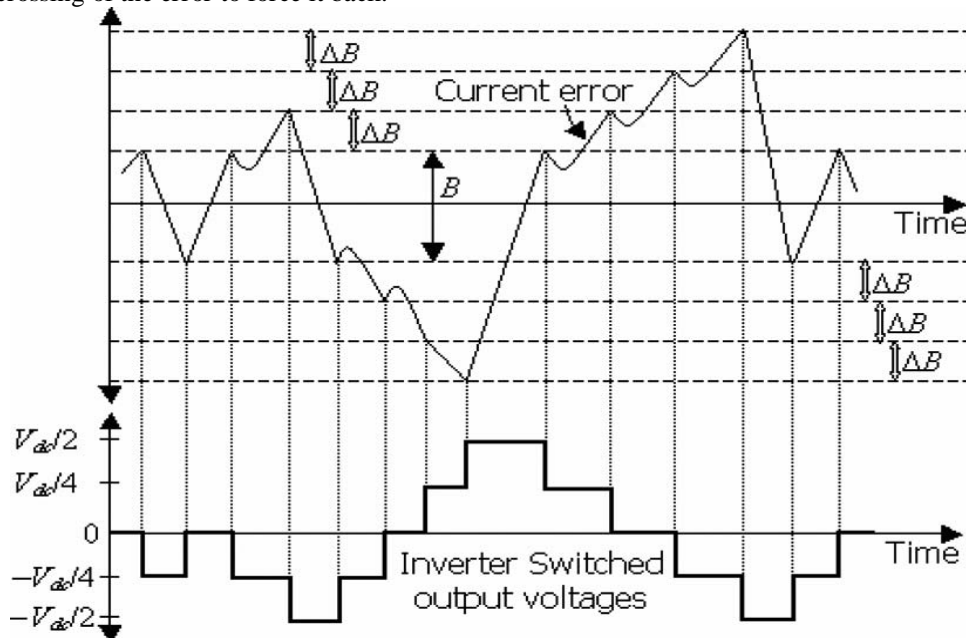

Figure: 2 Multi-band Hysteresis Modulation

### VII. Simulation Results for Multiband Hysteresis Modulation

To obtain an insight on the projected technique, a MATLAB simulation has been carried out. A five level Cascaded Multi Level Inverter has been simulated using MATLAB/SIMULINK block sets. Multi Band Hysteresis Modulation technique is designed and used to control the cascaded five level inverter. The output DC voltage waveform, gate pulses and FFT spectrum analysis graph have been presented.

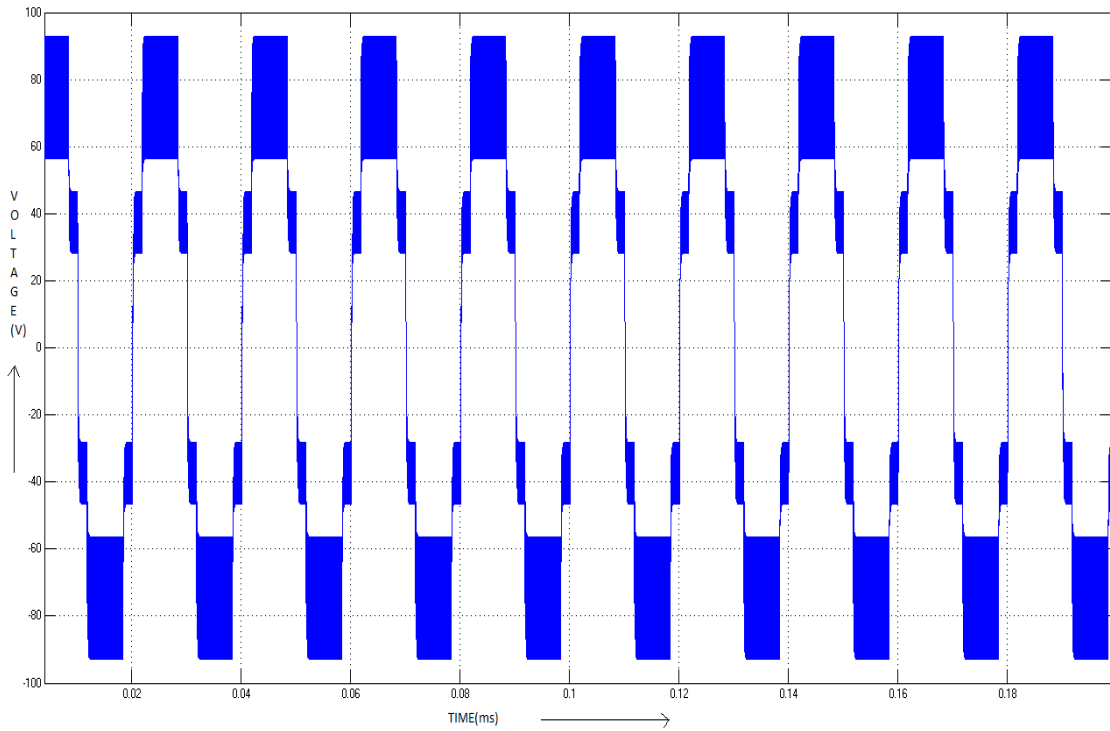

Figure 3: Simulated output voltage waveform

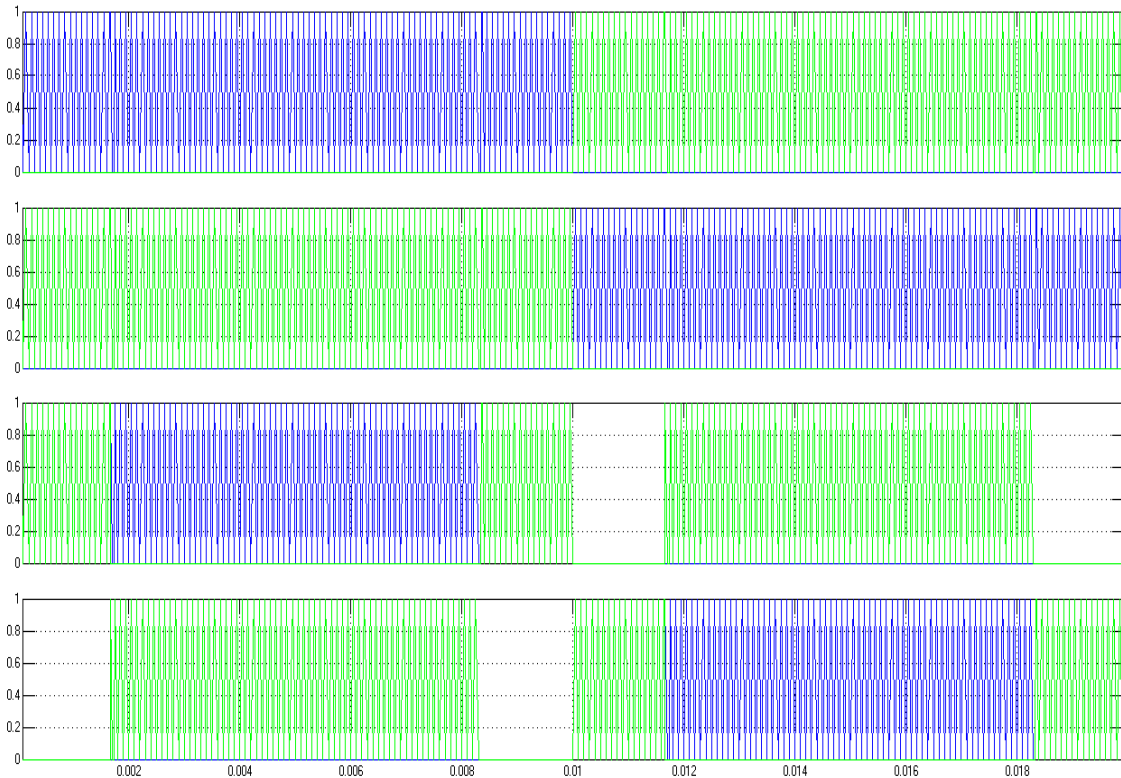

Figure 4: Gate pulse

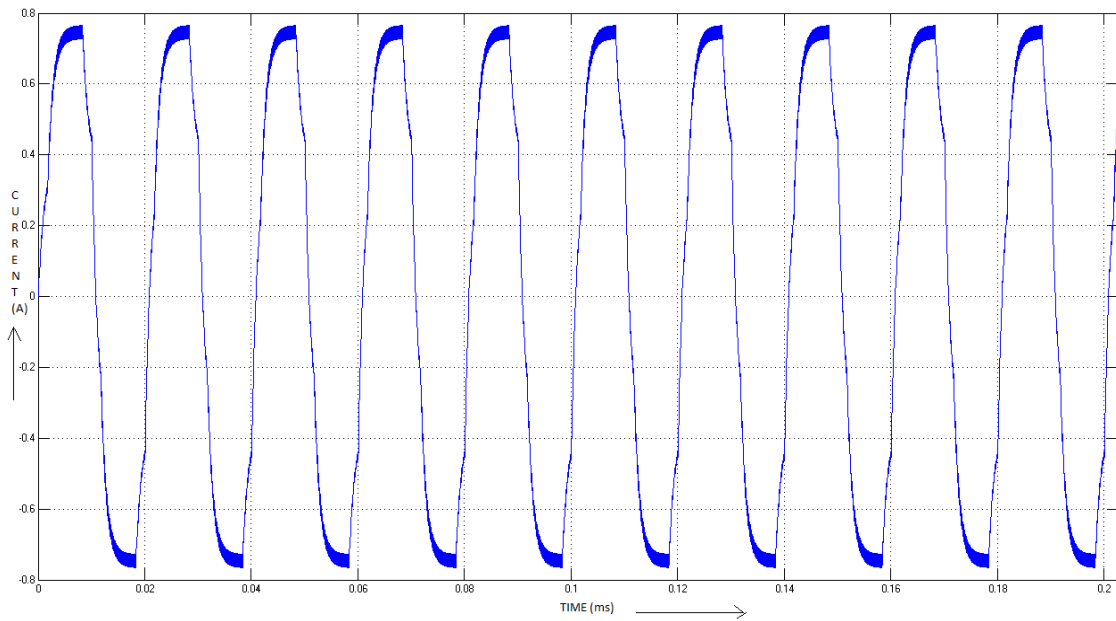

Figure 5: Simulated output current waveform

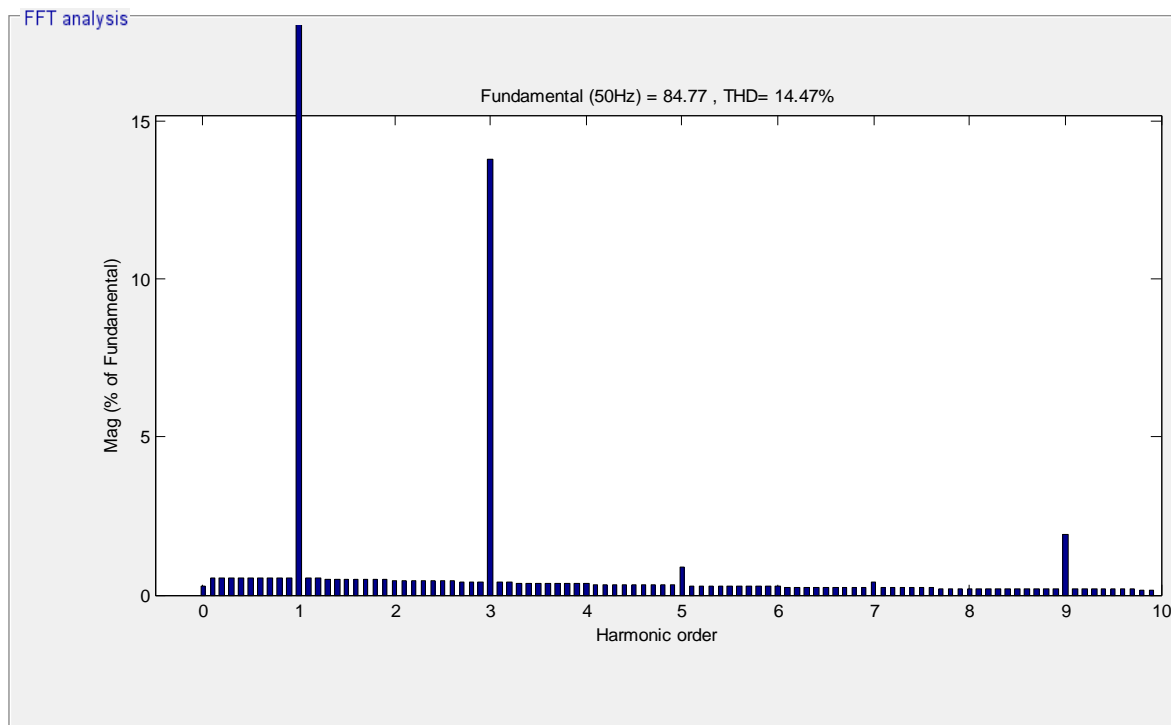

Figure 6: FFT spectrum of voltage

### VIII. Modified Time Based Hysteresis Modulation

A Modified Time Based (TB) MHM is presented which can be used to put a limit on maximum switching frequency as well as to achieve improved performances. The principle of controlling the system variable inside a single band such that any type of current offset can be evaded has been utilized in this method. This approach requires  $(n - 2)$  outer bands at  $\Delta B$  from their inner ones for an  $n$ -level inverter.

The modified TB approach, does not need to measure the current error, and therefore, does not suffer from noise amplification problem. Depending on the available number of output-phase voltage levels of the inverter, it requires a number of bands, but with the aim of containing the current error within the main band, i.e., the innermost band only. It also does not need to store the information of previous crossing point, as

opposed to the MB scheme. Therefore, the additional logical or analog circuitry requirement is minimal. Furthermore, the maximum possible switching frequency may be set by correspondingly designing the width of hysteresis band. The modified TB scheme keeps track of the switching duration between successive switching's and may be designed to always keep it larger than a certain allowed value. This modified TB control can be applied to the other multilevel hysteresis schemes as well [16]. The implementation of this TB control may be achieved by using a time counter with a programmable logic device or by programming it within a computer program itself. This method can be explained by using a five level inverter as shown in the Figure.7.

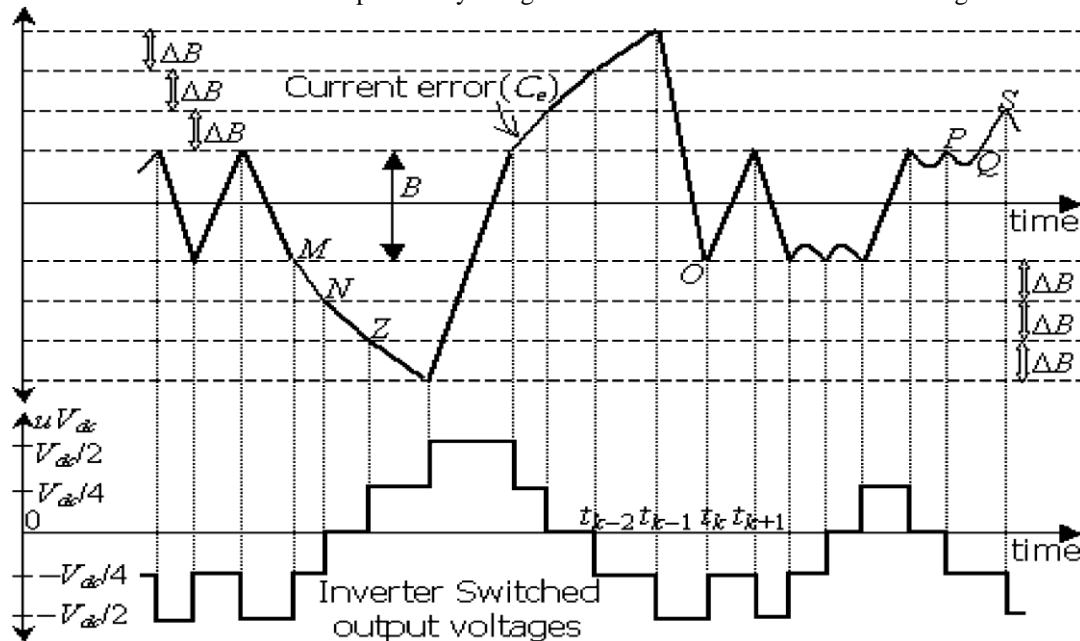

Figure.7 Modified TB five-level hysteresis current control.

In this Fig.5.1 the time interval between the instants P and Q is considered smaller than  $t_1$ , and therefore, another voltage level change does not occur at Q. Subsequently, the error reaches at S so that a change in voltage level causes its reversal. Therefore, in effect, this method replaces the current error derivative detection control by a number of fixed-width bands. The switching decisions are taken only at the boundaries of the bands when the current error moves away from the zero line. At each such crossing, the inverter output is changed by one step (e.g., from 0 to  $+V_{dc}/4$ , or to  $-V_{dc}/4$ , etc.). In the lower boundary regions, the output voltage state changes from lower to higher (i.e.,  $-V_{dc}/2$  to  $-V_{dc}/4$ ,  $-V_{dc}/4$  to 0, 0 to  $+V_{dc}/4$ , and  $+V_{dc}/4$  to  $+V_{dc}/2$ ) and in the upper boundary regions, from higher to lower (i.e.,  $V_{dc}/2$  to  $V_{dc}/4$ ,  $V_{dc}/4$  to 0, 0 to  $-V_{dc}/4$ , and  $-V_{dc}/4$  to  $-V_{dc}/2$ ). At the outermost boundaries, the corresponding extreme output voltage levels ( $+V_{dc}/2$  and  $-V_{dc}/2$ ) are applied for rapid current error reduction during transient conditions. These voltage level transitions ensure that the controlled current follows its reference with minimum control force needed. The switching strategy can be further understood from Fig.5.1. At point M, the current error crosses the lower boundary of B. Before this point, the output voltage state was  $-V_{dc}/2$ . Therefore, the next higher voltage level ( $-V_{dc}/4$ ) is applied at M. The current error then follows the path as shown, and at the crossing points shown in the figure (i.e., N, etc.), voltage state transition takes place as mentioned earlier. A total number of  $(n - 1)$  bands required for an n-level inverter in this scheme can be justified by following the current error trajectory. It is also clear that it can efficiently work under varying load conditions as well.

### IX. Simulation Results for Modified Time Based Hysteresis Modulation

To obtain an insight on the proposed technique MATLAB simulation is carried out. The five level Cascaded Multi Level Inverter is simulated using MATLAB/SIMULINK block sets. Modified Time Based Hysteresis Modulation technique is designed and used to control the cascaded five level inverter.

Figure.9 Displays the SIMULINK block diagram which consists of

- 100 Volts DC source with four MOSFET switches in the subsystem.
- 50 Volts DC source with four MOSFET switches in the subsystem 1.
- 1 ohm resistance and 5mH inductance.

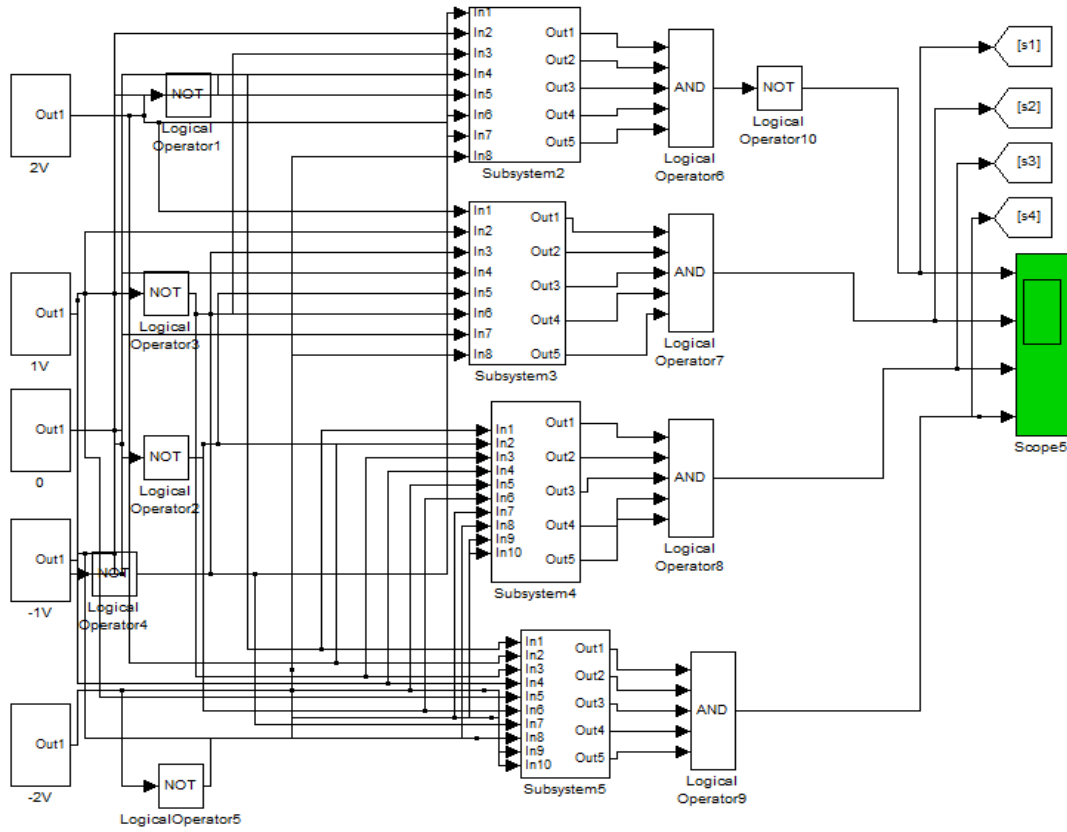

Figure.8 SIMULINK switching pulse diagram

Discrete,  
Ts = 5e-006 s.

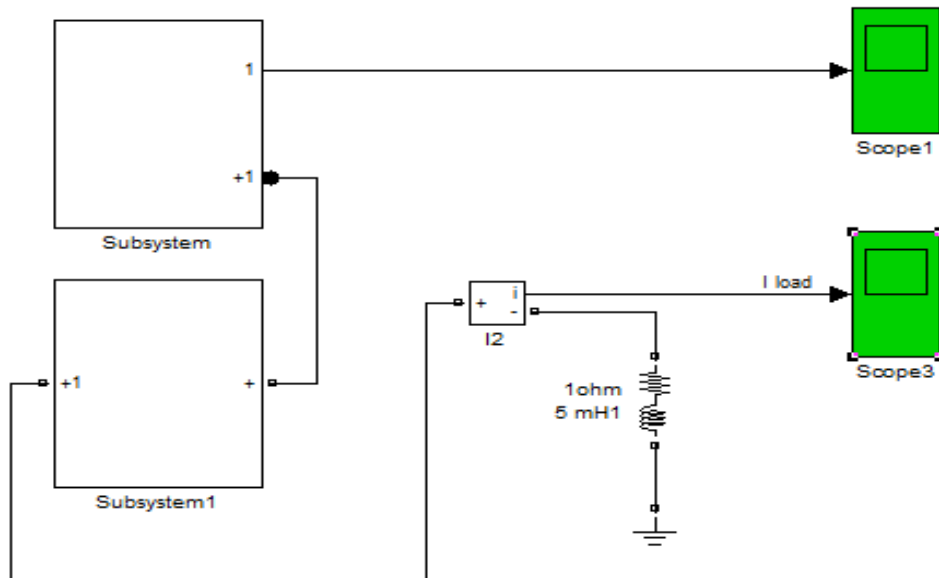

Figure.9 SIMULINK block diagram.

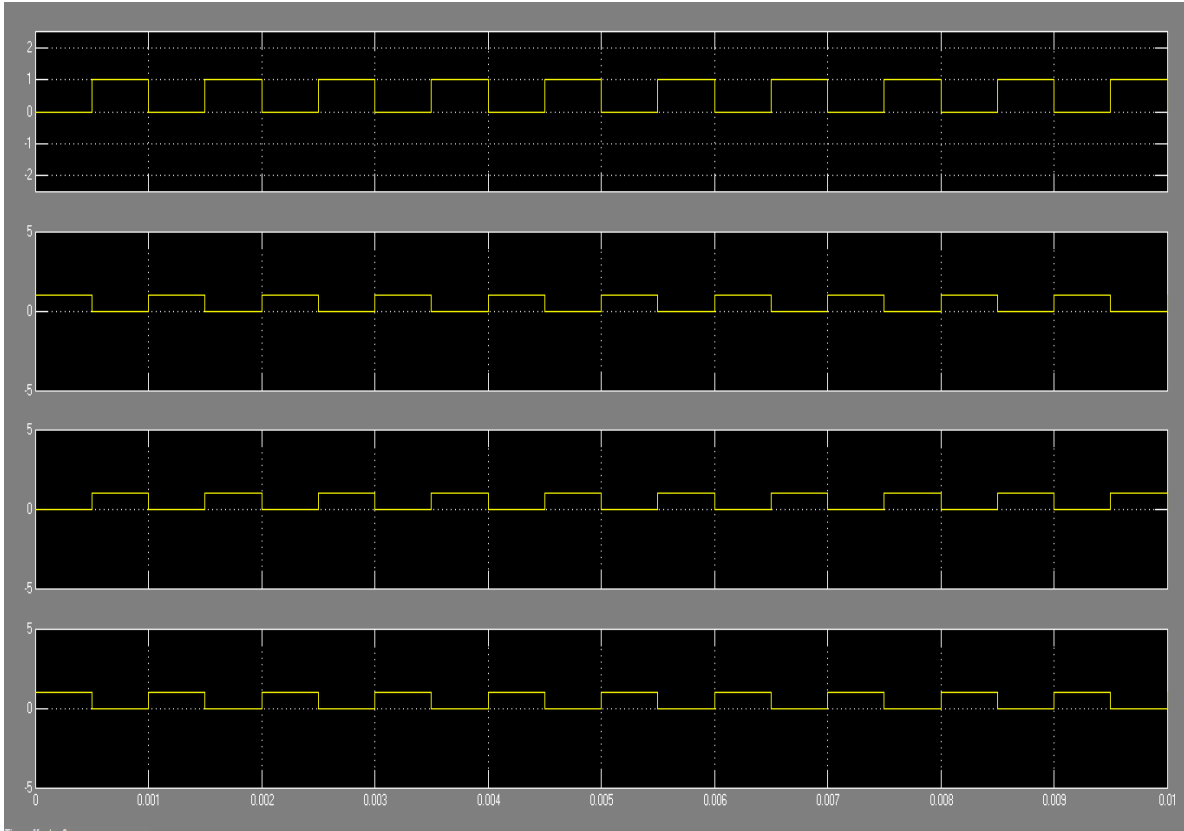

Figure.10 Switching pulses of multilevel inverter

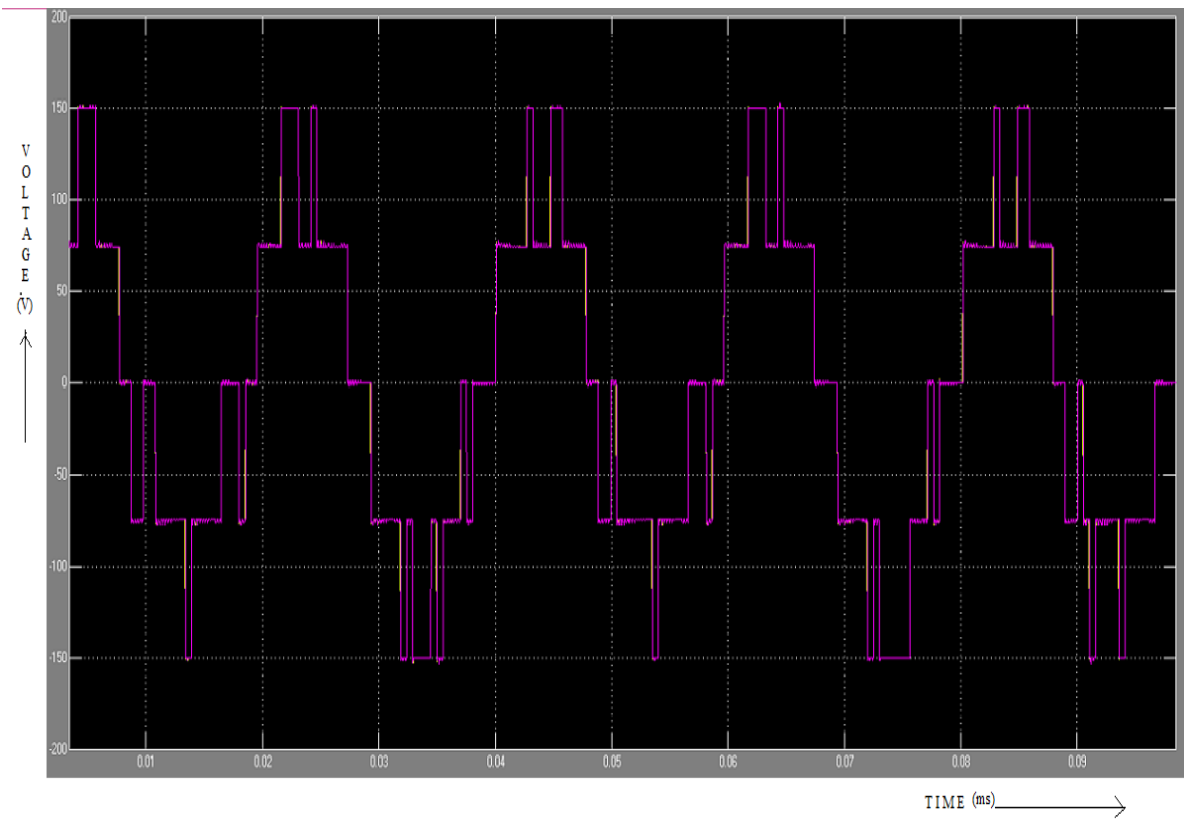

Figure.11 Simulated output voltage waveform



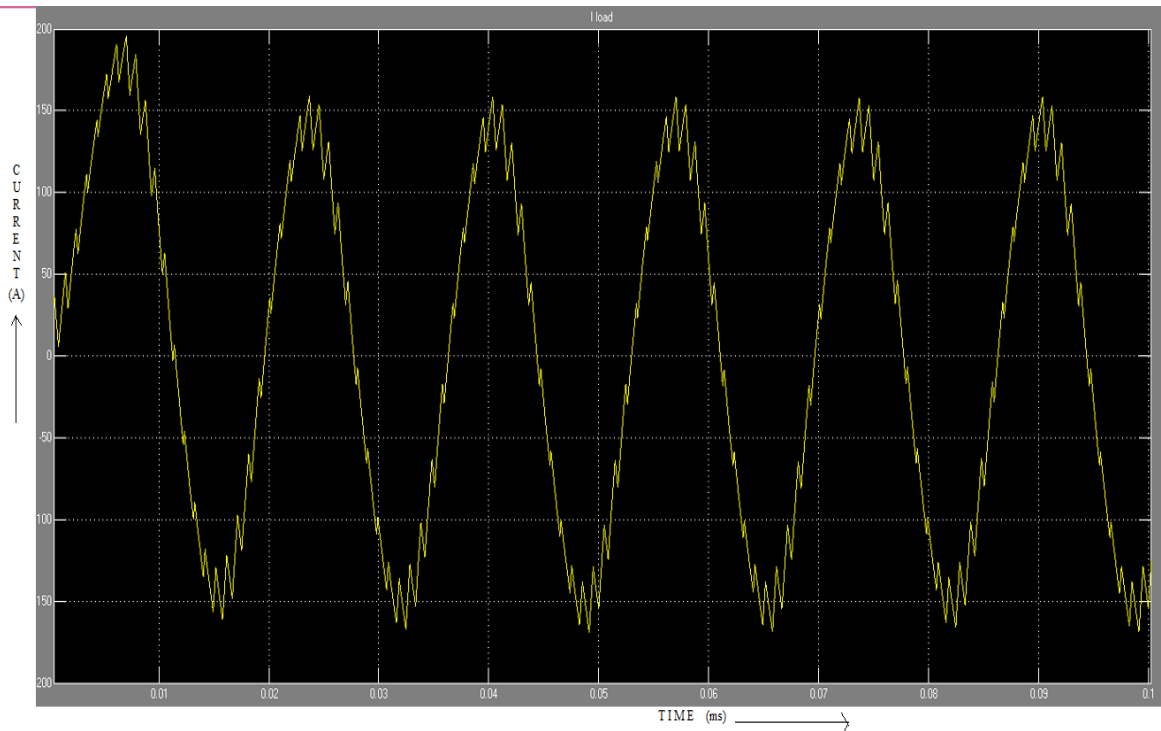

Figure.12 Simulated output current waveform.

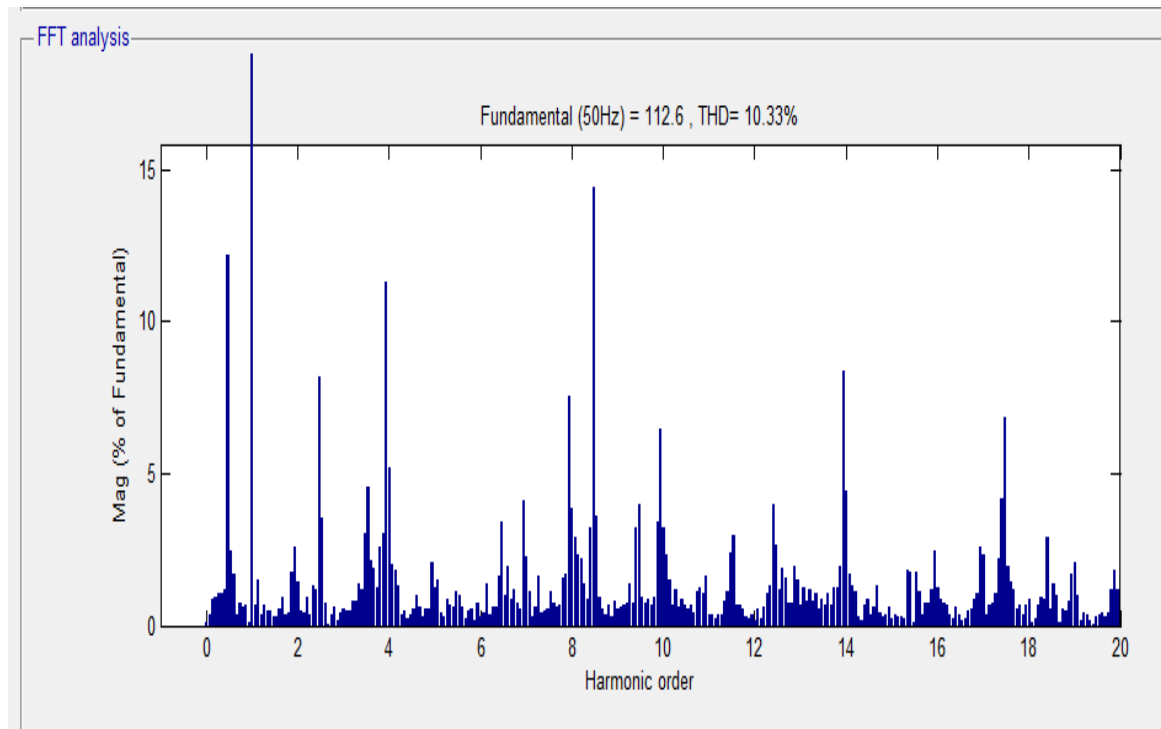

Figure.13 FFT spectrum of voltage

### X. Conclusion

This paper summarizes the analysis of Multi-Band and Modified Time Based hysteresis current control for reducing the total harmonic distortion level on a five level inverter. The MATLAB/ SIMULINK has been done for 100 Volts DC source with four MOSFET switches in the subsystem and 50 Volts DC source with four MOSFET switches in the subsystem1 considering one ohm resistance and 5mH inductance. The output voltage and current responses have been obtained for the corresponding FFT. From the FFT analysis it has

been absorbed that the THD level has decreased from 14.47 percentages in Multi-band hysteresis control to 10.33percentage in Modified time based hysteresis control. From this it has been concluded that time based hysteresis control provides much reduced THD than multi band hysteresis control.

#### REFERENCES

- [1] J.Chiasson, L.M.Tolbert, K.McKenzie and Z.Du, Eliminating harmonics in multilevel converter using resultant theory, in *Proceedings of IEEE Power Electronics Specialists Conference*, 2002, 503-508.
- [2] K.Gopakumar, J.Rodriguez, M.A.Perez, A Survey on Cascaded Multilevel Inverters, *IEEE Transactions on Industrial Electronics*, 57(7), 2010, 2197 - 2206.
- [3] P.M.Bhagwat and U.R.Stefanovic, Generalized structure of multilevel PWM inverter, *IEEE Trans. on Industry Applications*, 19(6), 1983, 1057-1069.
- [4] M.Manjrekar, P.K.Steimer and T.A.Lipo, Hybrid multilevel power conversion system: A competitive solution for high power applications, *IEEE Trans. on Industry Applications*, 36, 2000, 834-841.
- [5] J.Chiasson, L.M.Tolbert, K.McKenzie and Z.Du, A complete solution to the harmonic elimination problem, *IEEE Trans. on Power Electronics*, 19(2), 2004, 491-499.
- [6] P.N.Enjeti, P.D.Ziogas and J.F.Lindsay, Programmed PWM techniques to eliminate harmonics: a critical evaluation, *IEEE Trans. on Industry Applications*, 26, 1990, 302-316.
- [7] J.Vassallo, J.C.Clare and P.W.Wheeler, Power equalized harmonic-elimination scheme for utility-connected cascaded H-bridge multilevel converters, in *Proceedings of the 29th Annual Conference of the IEEE Industrial Electronics Society*, IECON'03, 2003, 1185-1190.
- [8] T. Tang, J. Han, and X. Tan, Selective harmonic elimination for a cascade multilevel inverter, in *Proc. IEEE Int. Symp. Ind. Electron.*, Jul. 2006, vol. 2, pp. 977-981.
- [9] Z. Du, L. M. Tolbert, and J. N. Chiasson, Active harmonic elimination for multilevel converters, *IEEE Trans. Power Electronics.*, 21(2), 2006, 459-469.
- [10] R. Salehi, N. Farokhnia, M. Abedi, and S. H. Fathi, Elimination of low order harmonics in multilevel inverter using genetic algorithm, *J. Power Electronics.*, 11(2), 2011, 132-139.
- [11] A.Shukla, A. Ghosh, and A. Joshi, Hysteresis modulation of multilevel inverters, *IEEE trans. Power electronics*, 26(5), 2011, 1396-1409.
- [12] K. A. Corzine, A hysteresis current-regulated control for multi-level drives, *IEEE Trans. Energy Conversion*, 15, 2000, 169-175.
- [13] F. Zare and G. Ledwich, A hysteresis current control for single phase multilevel voltage source inverters: PLD implementation, *IEEE Trans. Power Electron.*, 17(5), 2002, 731-738.
- [14] G. H. Bode and d. G. Holmes, Implementation of three level Hysteresis current controller for a single phase voltage source inverter, in *Proc. IEEE pesc '00*, 2000, 33-38.
- [15] R.Gupta, A.Ghosh and A.Joshi, Multiband hysteresis modulation and switching characterization for slide mode controlled cascaded multilevel inverter, *IEEE Transaction on Industrial Electronics*, 57(7), 2344-2353.
- [16] P.C.Loh, G.H.Bode, D.G.Holmes, and T.A.Lipo, A time-based double band hysteresis current regulation strategy for single phase multilevel inverters, *IEEE Trans. Ind. Appl.*, 39(3), 2003, 883-892.