

# Integration of Struts & Spring & Hibernate for Enterprise Applications

Deepak Kasgar<sup>1</sup>, Harish Chandra Maurya<sup>2</sup>

<sup>1</sup>(Department of Computer Science and Engineering, Bhagwant University, India

<sup>2</sup>(Department of Computer Science and Engineering, Bhagwant University, India

**ABSTRACT:** *The proposal of this paper is to present Spring Framework which is widely used in developing enterprise applications. Considering the current state where applications are developed using the EJB model, Spring Framework assert that ordinary java beans(POJO) can be utilize with minimal modifications. This modular framework can be used to develop the application faster and can reduce complexity. This paper will highlight the design overview of Spring Framework along with its features that have made the framework useful. The integration of multiple frameworks for an E-commerce system has also been addressed in this paper. This paper also proposes structure for a website based on integration of Spring, Hibernate and Struts Framework.*

**Keywords-** *Spring Framework, IOC, Struts, Hibernate, E-commerce*

## I. Introduction

Frameworks are abstraction layer on existing technology. If developer's directly works on technologies of java then project development time and cost will increase time to time. Non Invasive Frameworks does not force a developer to extend this class from a framework specific class or implement a framework specific interface. Spring framework is a complete and a modular framework. It means complete application can be developed using spring framework or some selective operations of the project can be developed using this modular framework. Even though java enterprise is widely used, it has some limitations such as transaction support, security, distributed computing [1],[5]. Spring framework has few advantages over other frameworks like:

- 1) Simplicity using POJO
- 2) Testability without using 3<sup>rd</sup> party servers or container
- 3) Dependency Injection

Spring framework has a layered architecture so when an E-commerce application is developed using spring framework it has clear separation of presentation layer, business layer, persistence layer. The layered architecture of spring framework allows users to select about which of its components users can use.

## II. Related Work

### 2.1 Architecture of Spring Framework

The architecture of spring has seven modules. The modules are as follows [2]:

- Core Container
- Spring Context
- Spring AOP
- Spring DAO
- Spring ORM
- Spring Web
- Spring MVC

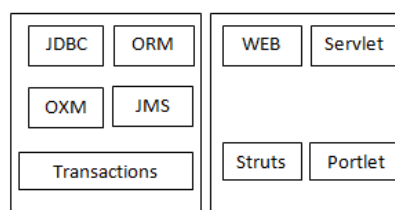

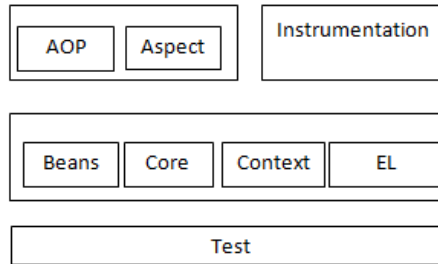

Fig 1 Architecture of Spring Framework

**2.2 Features of spring framework**

Spring is open source development framework that offers a lot of functions to programmers. A member of EJB team called Rod Thomson, has started company with name Interface21, and started experiment on ordinary java classes (POJO) to provide enterprise services to industry applications. Finally he succeeded in process of creating complex enterprise java application model as Spring Framework. The features of Spring Framework are the Inversion of Control, Aspect oriented programming and Spring MVC.

Aspect oriented Programming: This module provides separation of business logic services from the business operation. If services are implemented as part of business method then the following problem will arise [10].

- Boiler Plate code of Service
- Business class becomes complex.
- Managing business service become complex.

Example: considering an example of Banking System.

The various types of services such as Security, login, Transactions, Business operations are common in every transaction. Then the normal system for this would be as follows [6]:

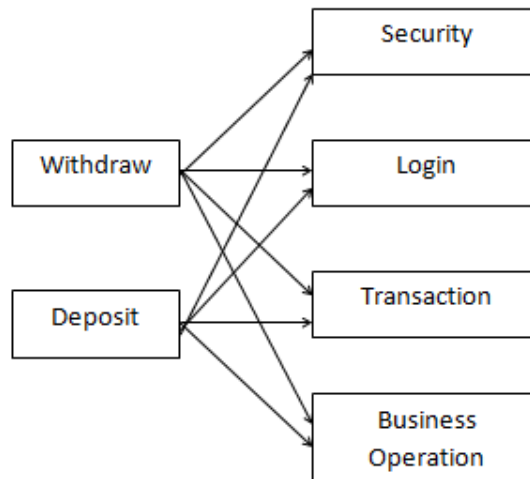

Inversion of Control: The central part of Spring Framework is Spring Container. It manages how beans are created configured and managed in a spring container. This module provides the functional/basics part of the spring framework called Dependency Injection.

The same system with the help of AOP can be drawn as follows: All the four functionalities are provided to one class named as service [6].

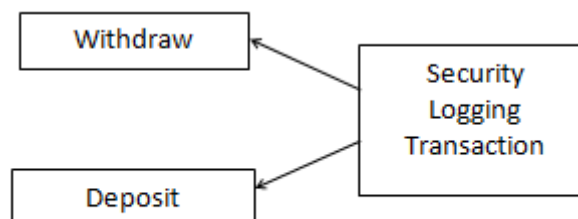

Fig 3 Approach using AOP

### 2.3 Spring MVC Model

The Spring Framework provides its own MVC model. The major components of Spring MVC are as follows [3]:

DispatcherServlet- DispatcherServlet uses HandlerMapping and forwards the request to concerned controller.

Controller- It handles the request and is created by user. They are objects that can respond to the actions a user takes like form filling or clicking a link.

View- It can be imagined as method of presenting the output to the users.

ModelAndView- Model means data which is accessible in that view. Model is the data in the form of key/value pair

ViewResolver- ViewResolver is a bean which finds an appropriate view for the logical name set for ModelAndView object.

HandlerMapping- Whenever DispatcherServlet receives incoming requests it associates the request to individual controllers with the help of this component.

The MVC model of Spring Framework can be shown as below [6]:

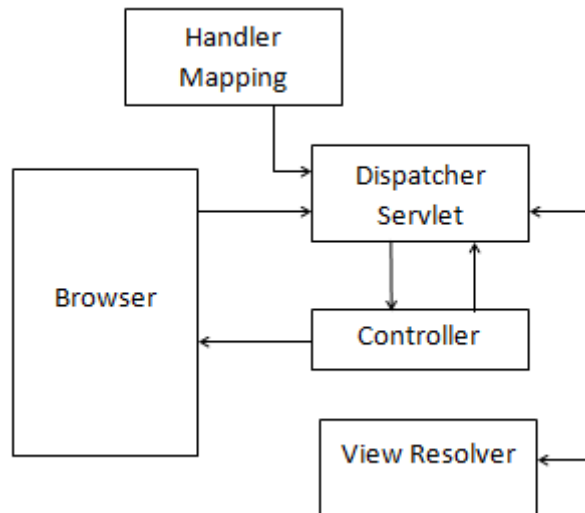

### 2.4 Spring and xml

XML stands for Extensible Markup Language. XML is widely used in frameworks for configuring information. The information can be processed by parsers. Xml files can be modified and the change can be seen throughout the application. Xml files need not to be compiled so time needed in deployment to servers can be saved. There are three types of xml files:

- web.xml file
- applicationContext.xml file
- DispatcherServlet.xml file

web.xml:

Whenever a request is made by a user then web.xml file forwards the request to DispatcherServlet which is being specified in the web.xml file. The web.xml file specifies the xml version number and name of DispatcherServlet [3].

The DispatcherServlet can be configured as shown:

```
<servlet>
<servlet-name>dispatcher</servlet-name><servlet-class>
org.springframework.web.servlet.DispatcherServlet</servlet-class>
<load-on-startup>1</load-on-startup>
</servlet>
```

The name of servlet is given as “dispatcher” and load-on-startup indicates that it should be the first to execute when called.

The type of URLs that can be handled by the DispatcherServlet can be shown using

```
<url-pattern> element.
<servlet-mapping>
<servlet-name>dispatcher</servlet-name>
```

```
<url-pattern>/send/*</url-pattern>  
</servlet-mapping>
```

*ApplicationContext.xml:*

ApplicationContext containers can provide multiples functionality like AOP, Messaging, Scheduling, Event Handling, and Internationalization [3].

```
<bean id="superClass" class="packagename.SuperClass" />  
<bean id="subClass" class=" packagename.SubClass">  
</bean>  
<property name="superClass" ref="superClass"/>  
</beans>
```

This file loads the bean of SuperClass.java and SubClass.java.  
DispatcherServlet.xml:

When a request is sent from a browser front controller servlet of spring MVC called DispatcherServlet traps the given request. DispatcherServlet takes the help of Handler Mapping class to find a suitable controller for handling the request[3].

```
<bean id="viewResolver" class="org.springframework.web.servlet.view.InternalResourceViewResolver">  
<property name="prefix">  
<value>/WEB-INF/views/</value></property>  
<property name="suffix"><value>.jsp</value></property>  
</bean>  
<bean id="urlMapping" class="org.springframework.web.servlet.handler.SimpleUrlHandlerMapping">  
<property name="mappings">  
<props><prop key ="/*">dispatchController</prop>  
</props>  
</property>  
</bean>  
<bean id="dispatchController" class=" packagename.DispatchController"></bean>  
</beans>
```

**2.5 E-Commerce System Using Spring and other frameworks**

This modular framework can be used with many other frameworks for making of an E-commerce application such as struts and hibernate.

Struts framework: This framework divides web system into three layers: Model, View and Controller. Model consists of JavaBeans, EJB; View consists of JSP files; Controller is carried out by Actions [4].

The architecture of struts can be shown as below [2]:

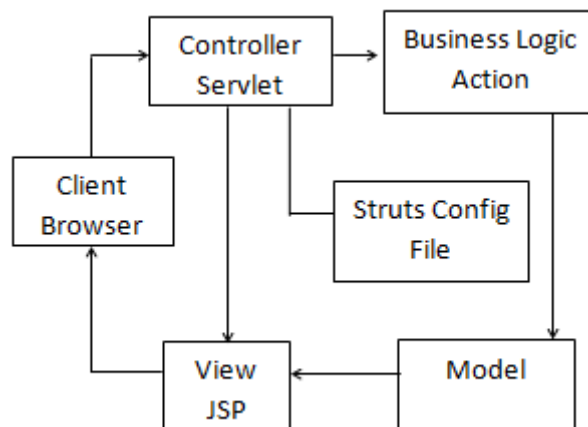

The structure of Hibernate can be shown as below [2]:

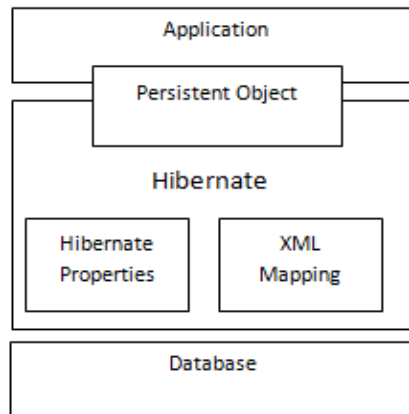

**Fig 6 Structure of Hibernate**

Hibernate framework: This framework minimize the complications and difficulty of writing the SQL statements. It charts Java classes to database tables efficiently. It is mainly associated with databases [3],[4].

**Integration of Struts, Spring and Hibernate**

Struts, Spring and Hibernate frameworks can be integrated together to develop an E-commerce applications. The struts framework with an efficient MVC can help in developing the presentation tier. The Spring framework can take care about business logic. The Hibernate framework can help in persisting data and retrieving the data to and from database respectively.

The architecture based on integration of above frameworks can be shown as below [1]:

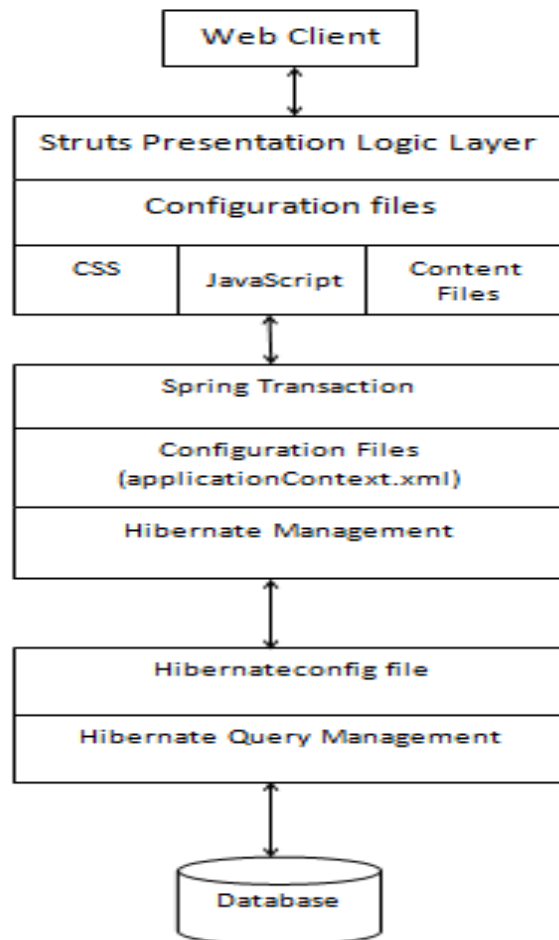

**Fig 7 Architecture based on Spring, Struts and Hibernate.**

### III. PROPOSED SYSTEM

Spring framework which is modular and having a multitier architecture can be used with multiple other frameworks such as Struts, Hibernate. Although spring has its own MVC which can be used in developing the entire application.

The proposed system can be considered here with the help of a website such as that of a Shopping Cart where user requests items and buys items. It generally has three layer i.e. presentation layer, business layer and database layer.

#### A. Presentation layer:

The Presentation Tier is generally responsible for displaying the output on screen in a look and feel appearance. User Interface is the user sees when they open a web page in the browser. It is what is presented to the user on the client side within their web browser. It is responsible for handling requests and forwarding the response back to client. It provides with the views that can be provided to the users such as Jsp, HTML documents. The presentation layer can be done using either spring MVC or struts.

#### B. Business layer:

The business layer is also called as functional Process Logic, Business Rules and all the logic related to functionality can be kept in Business layer. In this layer we can typically define POJO, beans, interfaces, classes, functions, procedures, properties file. The business layer can be handled using spring framework because it has various features such as scheduling, dependency injection, internationalization, distributed transactions.

#### C. Data Access layer:

The data access layer or persistence layer can used for connectivity with any database. It can handle several operations called by user including creation of databases.

The general architecture for the three tier can be as follows:

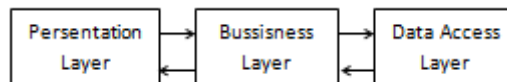

The proposed architecture for the website consisting of the three layers is as follows:

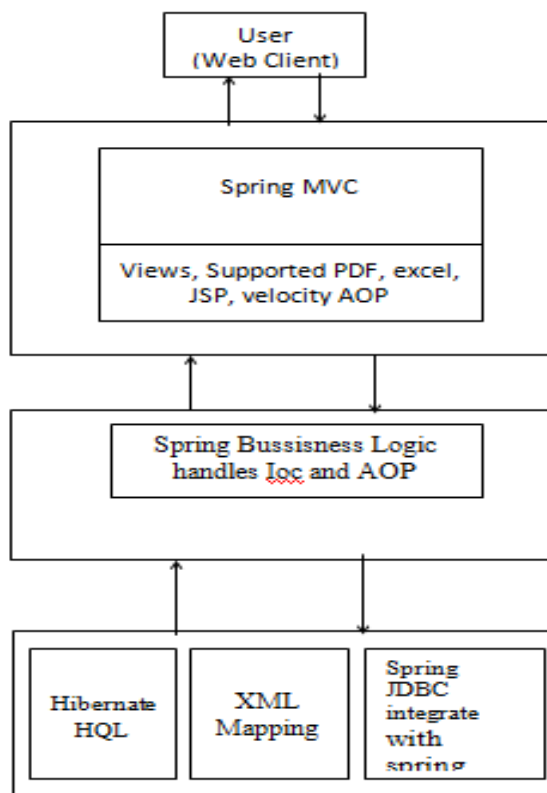

The above architecture can be explained as follows in terms of model, view and controller.

A) Responsibilities of Model

- Reads data sent by a controller.
- Apply business logic for the given data.
- If required store/read data from database
- Returns the result of business operation back to controller.

B) Responsibilities of View

- Read the data produced by a model.
- Apply presentation required for data.
- Render the response to browser.

C) Responsibilities of Controller

- Accept the request send by a client.
- Find suitable model for a request.
- Calls appropriate model component.
- Gets the result from model.
- Call suitable view to display the result.

Form Field Validation- Struts provide two ways of validations:

- Client Side.
- Server Side.

Now day's struts framework is used in presentation layer of application but there are many other competitor for it like: Spring Framework which has its own MVC, Stripes, and Wicket. But Struts has its own limitations which can be stated as:

- 1) Testing is impossible without server.
- 2) Struts version 1.x supports less number of views as compared to Spring MVC.
- 3) Documentation is not properly organized so difficulty arises for developers.

Benefits of Spring MVC over Struts are as follows-

- 1) Spring MVC uses interface approach which avoids concrete inheritance between action and form objects.
- 2) Using Spring IOC testing of objects without server is possible.

Although Spring MVC has its own added advantages it also comes with some limitations such-

- 1) Spring MVC requires extensive XML configuration files which can become tedious.
- 2) Spring MVC does not support AJAX-Asynchronous JavaScript which is a newer trend in developing web application
- 3) The Spring framework acts as a good contender for the middle tier because of its Aspect Oriented Programming and Inversion of Control.

The main approach of developing application using Spring Framework is as follows:

- 1) The Spring framework provides its own MVC. Developers sometime feel more comfortable with some other framework such as Struts so spring easily get integrated with such frameworks.
- 2) The Spring framework has the main functionality as Inversion of Control and Aspect Oriented Programming which can be effectively used to handle the business objects.
- 3) The Spring framework can also be easily integrated with other ORM tool such as Hibernate, iBATIS.

The ORM tool is a tool that performs mapping from Object to relational tables. Hibernate is one such ORM tool. The spring framework follows DAO module which can be helpful to connect any ORM tool.

The Hibernate ORM tool can be easily integrated with spring with the help of XML mapping. The spring framework when used with Hibernate for data access and Struts for Web presentation can help in developing web application in an efficient manner.

#### **IV. Discussion**

The spring framework has MVC model. Struts framework which is used for presentation tier also has MVC model. But there are some differences between the two with regards to the MVC model. The differences can be explained as follows[17]:

- 1) The Spring MVC supports more number of views than that of the struts1.x such as struts1.x only supports JSP and Tiles, but spring MVC supports Velocity, PDF, excel in addition to JSP and Tiles.
- 2) Spring MVC is well organized as compared to struts.
- 3) Struts framework has been around for long time, so it is easy for use as compared to spring because documentation of spring has to be read before using it.
- 4) Spring MVC web tier are easier to test because the testing can be performed without server.



5) With the help of spring MVC all tiers can be used, but struts can only be used for web tier.

The above differences between struts web tier and spring MVC are minimal. Making comparison between struts 2.x and spring both of them are very much same with the arrival of changes from struts 1.x to struts 2.x

The spring framework has its own JDBC module for data access but it can be compared with Hibernate based on how connection is done between database and application.

JDBC vs Hibernate

1) If developer go with JDBC connection he has to write code to map object into relational tables, Hibernate map object into relational tables using the xml files so developers needs to write the code to map java classes to database tables.

2) Scalability of Hibernate is very good for high performance applications as compared to JDBC.

## V. Architectural Benefits Of Spring

There are multiple architectural benefits of spring framework. They can be described as following [3]:

1) Spring Framework can be efficiently integrate with other frameworks such as struts, hibernate.

2) Spring provides easy access to database by using hibernate framework and avoiding the handling of error mechanism.

3) Applications developed using spring framework depends on few APIs.

4) Due to its Inversion of Control feature the amount of time needed for testing the code is less.

5) Because Spring is a layered architecture users can select which of its components can be used.

6) The Spring Web MVC framework is flexible, robust and well designed for rapidly developing web applications.

7) Spring Framework can work effectively with J2EE for developing applications in an effective manner.

## VI. Conclusions

Being a modular framework spring is a powerful framework for developing enterprise applications. It can also be easily integrated with hibernate, struts and frameworks for developing complete enterprise applications thereby reducing the coupling and clear separation of layers. Due to its lightweight feature it is easy to use. Web servers such as Tomcat can also be used during integration of spring with other frameworks. Considering the present scenario wherein there is struts2 framework that can be implemented for web tier spring framework can be used effectively for all the three tiers to build an efficient enterprise application. The spring framework can be easily be integrated with any ORM tool such as Hibernate, iBATIS.

## REFERENCES

- [1] Chunsheng Zhao, Mai Jiang, Zhiyong He, "The Design of E-Commerce System Architecture Based on Struts2, Spring and Hibernate", IEEE Transaction Paper Dated 2010.
- [2] JiyaJiang , Tong Liu , Yu Liu, "The Construction of E-Business Portal Based on Struts, Spring and Hibernate", IEEE Transaction Paper Dated 2009.
- [3] Praveen Gupta, Prof. M.C. Govil, "Spring Web MVC Framework for rapid open source J2EE application development: a case study", International Journal of Engineering Science and Technology, Vol. 2(6), 2010, 1684-1689
- [4] Praveen Gupta, Prof. M.C. Govil, " MVC Design Pattern for the multi framework distributed applications using XML, spring and struts framework" , International Journal on Computer Science and Engineering, Vol. 02, No. 04, 2010, 1047-1051
- [5] Rod Johnson et, "Professional Java Development with the Spring Framework", Publications John Wiley & Sons 2005
- [6] Craig Walls with Ryan Breidenbach, " Spring in Action" , Publications Manning 2008
- [7] Introduction to the Spring framework accessed from: <http://www.ibm.com/developerworks/web/library/wa-Spring1/>
- [8] Model-View-controller Accessed from: <http://en.wikipedia.org/wiki/Model-view-controller>
- [9] Hao, Xiafei, Tang, Hongxi. "Struts+Spring+Hibernate Integrated Framework and its Use in Log Accounting and analyzing System", International Conference Dated 2010.
- [10] KeJu, Jiang Bo, " Applying IoC and AOP to the Architecture of Reflective Middleware", International Conference Dated 2007.
- [11] "Research of Structure Integration based on Struts and Hibernate", IEEE Conference 2010.
- [12] Erxiang Chen Personnel department "Research and Design on Library Management System Based on Struts and Hibernate Framework", IEEE Conference 2009.
- [13] Hui Li, Jingjun Zhang, Lei Wang, " The Research and Application of Web-Based System with Aspect-Oriented Features", IEEE International Conference Dated 2010.
- [14] DipankarMajumdar, "Migration from Procedural Programming to Aspect Oriented Paradigm", IEEE International Conference Dated 2009.
- [15] Hui Li ,GuiJun Xu , Mingji Zhou, Lingling Si, "Aspect-oriented Programming for MVC Framework" , IEEE Paper Dated 2010.
- [16] Robert J. Walker, Elisa L.A. Baniassad and Gail C. Murphy, "An Initial Assessment of Aspect-oriented Programming", ACM Paper Dated 2009.