

## Enhancement of Track Guide Design

Mootaz. E. Abo-Elnor\*,

**ABSTRACT:** Track rollers are usually subjected to heavy stresses during guide and launching processes. Design of such roller system to withstand high dynamic loads during guiding and launching processes may lead to massive structure of the launcher such in mobile bridges launchers. The feature-based modeling technology in computer aided design (CAD) has been widely studied, which greatly facilitates the manufacture of the design. In this study computer aided engineering (CAE) techniques was used in design of a smart bridge launcher guide which insure satisfaction distribution of the applied dynamic loads during launching and enhancing roller system design. Results show that roller system design has significant effect on rolling resistance and overall launching process.

**Keywords:** Self-aligning; track guide; tandem rollers assembly

### I. Introduction

In the production of a relatively large mechanism such in mobile bridges, the process of assembly is not fairly simple to merely bringing the individual components of the mechanism with no manual adjustment. However, it is not particularly difficult to attain the precise dimensions of such mechanism links that are made up of several parts which, when connected, might have their tolerances added together beyond the permissible value. It is, therefore, very important to select the design of a mechanism so that the accuracy requirements should be relatively low and hence having their links self-aligning [1].

Not only the production accuracy and precise assembly of mechanism individual components has significant effect on the mechanism performance and overall moving resistance but also service life, elastic performance, thermal expansion and components wear may cause general failure in such mechanism performance.

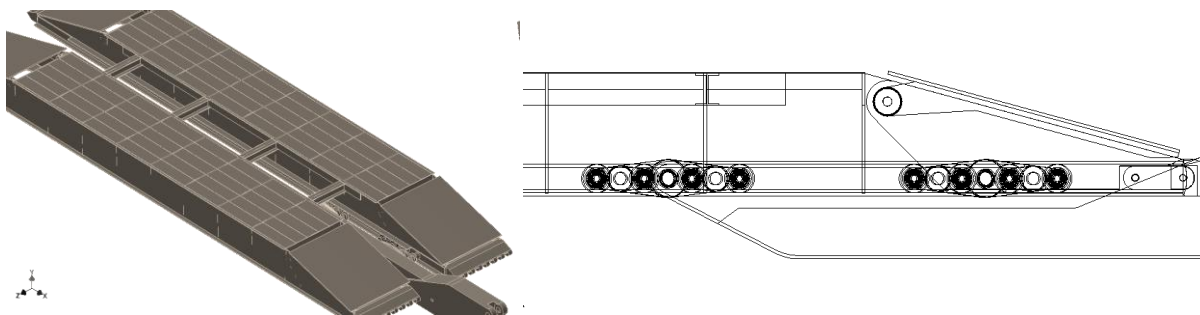

**Fig. (1) Rapid launcher with traditional tandem rollers**

In rapid deployment (mobile) bridge launcher, figure (1), having tandem rollers to insure fairly distribution of track load over guide rollers is not sufficient to overcome misalignment of launching track which may exist due to production accuracy, assembly tolerance [2], or operational deformation. Track rollers assembly enhancement is developed in this publication and qualitative comparison between traditional tandem rollers assembly and the developed one is carried out to represent the advantage of the proposed developed assembly over the traditional one.

### II. Materials and Methods:

In rapid deployment mechanical bridges, the launching mechanism and process is one of the important issues to decrease launching time and effort during bridge laying process. The bridge main girder includes track guide is made of several components assembled together even by welding or bolted connection. Due to the large size of the bridge which sometimes reaches 30 meter long, one meter depth, and 3 meter width [3], deflection of the track guide can be exists and affects launching process. Tandem rollers assembly, figure (2), is designed to

establish fairly distribution of track reactions during launching of such bridges but it cannot stand for production extra tolerances or over estimated elastic or plastic deflection of girder track guide.

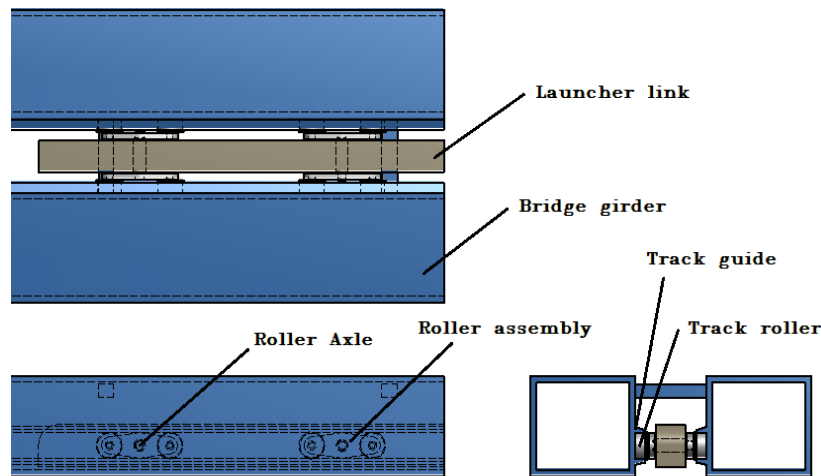

Fig. (2) Launcher mechanism components

**Traditional track rollers assembly**

In traditional tandem track rollers assembly, roller axle is of concentric geometry i.e. the two sides' pair of rollers assembly is in the same axis of roller axle. And hence the coupling rollers assemblies of front and rear rollers groups are in the same level, figure (3).

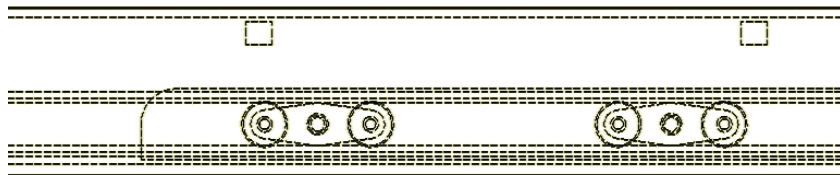

Fig. (3) Traditional rollers assembly with normal track guide

To examine the performance of track guide rollers in high deflection or tolerated production quality, a 5mm deflection was introduced all over a 10 meter long girder, figure (4).

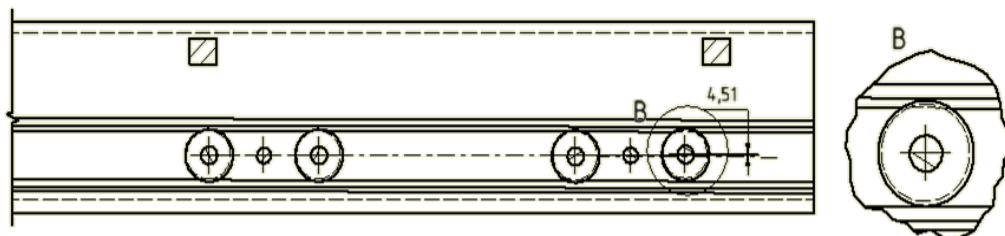

Fig. (4) Traditional rollers assembly with deformed track guide

As shown in figure (4), an overlap of about 4.5 mm is established at one roller pair which is impossible to valid in practical and hence failure of bridge launching process should occurs, as will discussed later on in this publication.

**Proposed developed track rollers assembly**

In order to decrease the effect of large deformation and production tolerances a developed rollers assembly is introduced in this study. The key point of the proposed development is to replace the concentric rollers group axle with an eccentric one as shown in figure (5).

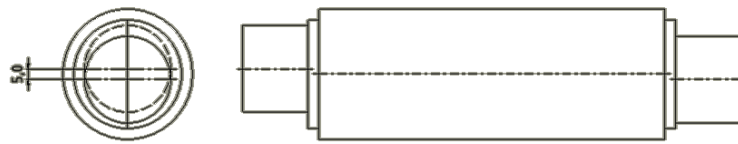

Fig. (5), 5mm eccentric rollers axle

As done in the traditional rollers discussed in the previous section, a 5 mm deflection was introduced along a 10 meter track guide. The geometric assembly of the system shows a gap of about 0.75 mm when using the developed axle, figure (6), which reveals the advantage of the proposed eccentric axle over the traditional concentric one.

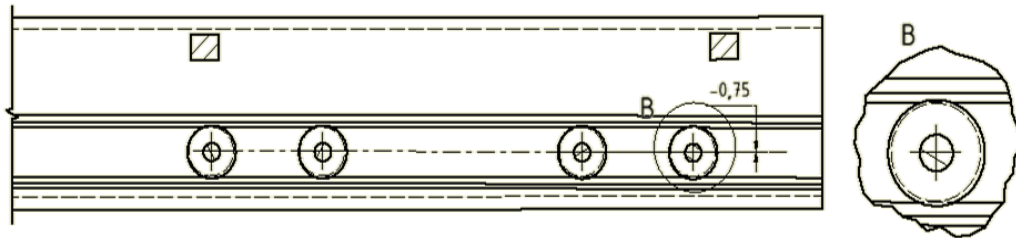

Fig. (6), Developed rollers assembly with deformed track guide

Motion analysis of launching process was simulated using Solid Works motion analysis module [4]. Both traditional and developed rollers assembly were analyzed for normal track guide and deformed one. Rollers reaction was calculated along with launching resistance forces during launching process with 100 mm/s launching speed.

### III. Results and Discussion

Forces acting on track rollers are plotted for both front rollers and rear rollers assuming normal track guide for both traditional rollers assembly (concentric axle), figure (7), and developed rollers assembly (eccentric axle), figure (8). Results show regular distribution of forces over track rollers for both cases.

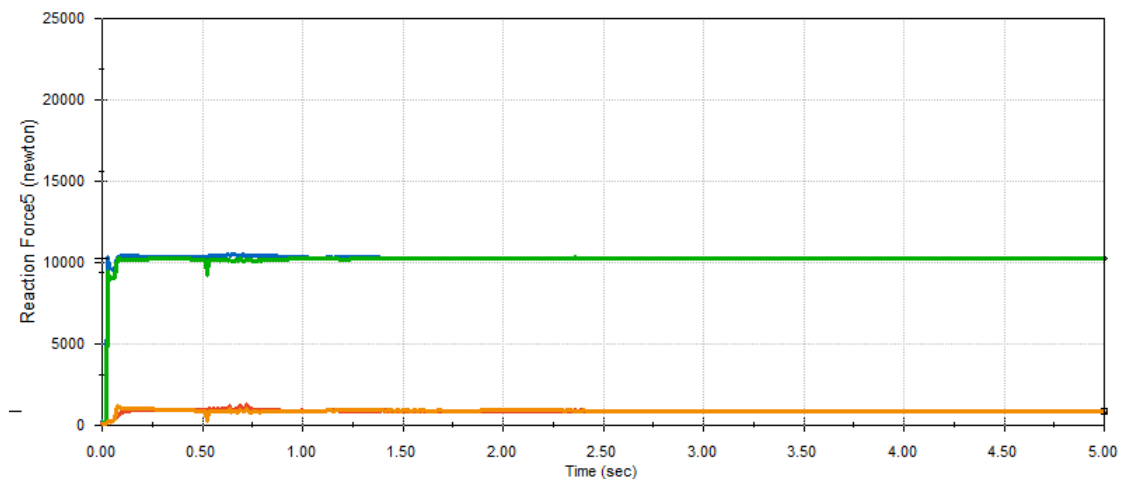
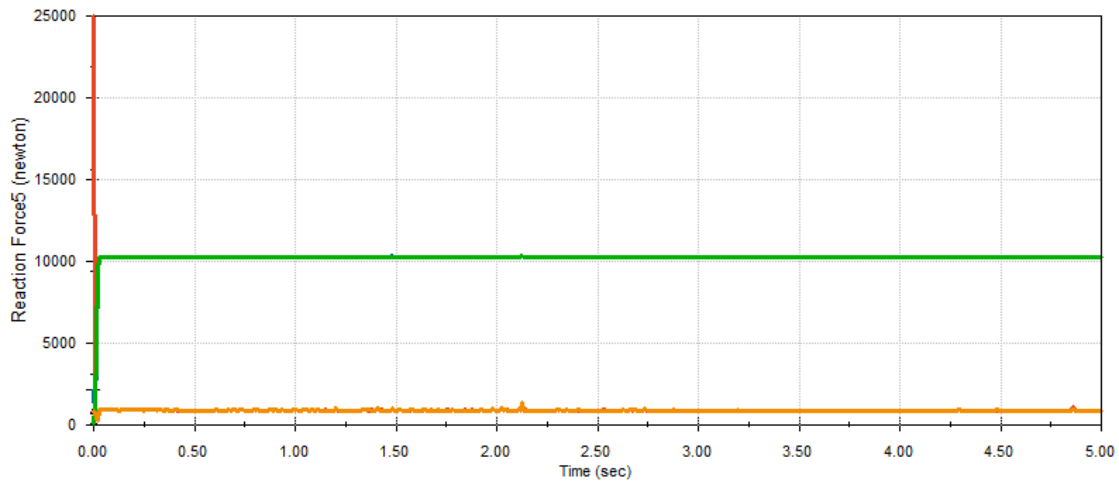
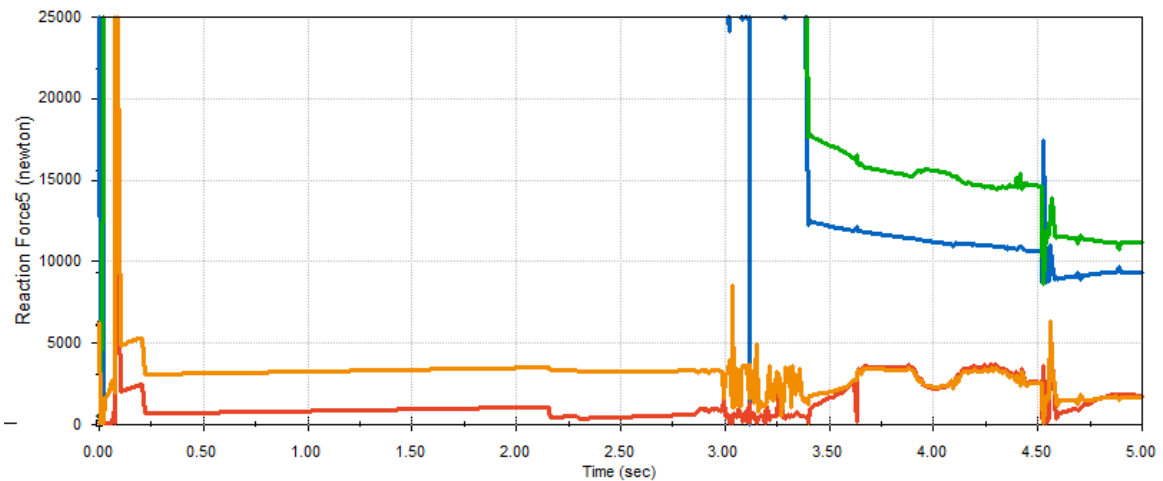

Fig. (7) Rollers reactions (Normal track guide with concentric rollers axle)

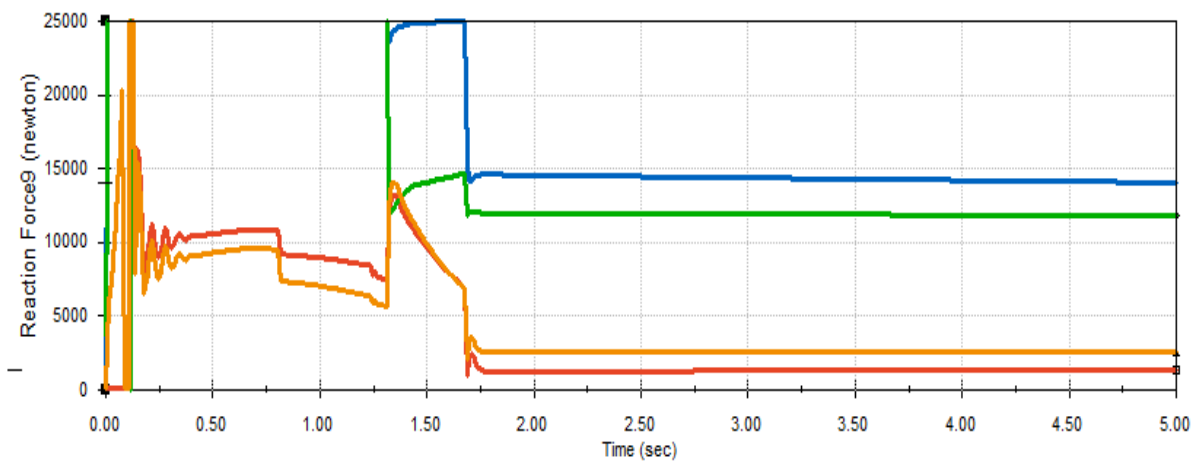

**Fig. (8) Rollers reactions (Normal track guide with eccentric rollers axle)**

In the case where track guide deformation takes place, forces acting on track rollers with traditional rollers assembly (concentric axle) shows severe disturbance on reaction forces before failure of the launching process, figure (9). But in the case of using the proposed developed rollers assembly (eccentric axle), normal distribution of reaction forces over both front and rear axle rollers after contact establishment can be easily shown in figure (10).



**Fig. (9) Rollers reactions (Deformed track guide with concentric rollers axle)**



**Fig. (10) Rollers reactions (Deformed track guide with eccentric rollers axle)**

To conclude this analysis, resistance forces of launching mechanism is plotted during launching process of 10 mm/s for normal and deformed track guide using traditional and developed rollers assembly, figure (11). Results show that with normal (healthy) track guide; both traditional and developed rollers assembly faces almost same resistance. For the deformed track guide, traditional rollers assembly (concentric axle) faces severresistance and failure in launching process while the developed rollers assembly (eccentric axle) faces high resistance and succeed to complete the launching process.

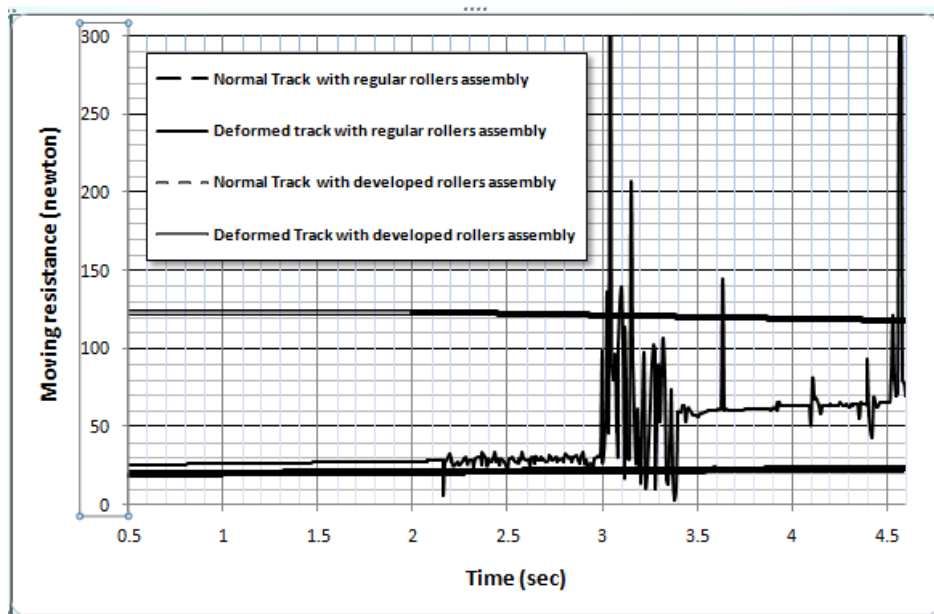

Fig. (11) Launcher resistance forces

#### IV. Conclusion

A developed rollers assembly is introduced using an eccentric axle to avoid production and assembly tolerances problems of launching rapid deployment mechanical bridges. Numerical analysis of the proposed system was carried out along with the traditional tandem rollers assembly with concentric axle. Results show that for healthy (non-deformed) track guide, the effect of using eccentric axle is not significant over the traditional one. While with deformed track guide, the proposed developed rollers assembly using eccentric axle succeeds to complete launching process with high resistance. As a result, the developed rollers assembly with eccentric axle can be used to solve launching problems of tolerances and deformation.

#### References

- [1]. Self-Aligning Mechanisms, L. Reshetov, Mir Publishers, Moscow, 1986
- [2]. Larsen, Glen C. , A Generalized Approach to Kinematic Modeling for Tolerance Analysis of
- [3]. Mechanical Assemblies, Brigham Young University Master’s Thesis, August 1991. [<http://www.army-technology.com/contractors/engineering/cnim>]
- [4]. DS SolidWorks, USA, 2011