

Android Interface based GSM Home Security System

Santhosh Kumar. K, Mukesh.G, Deepti.K

Department of Electronics & Communication Engineering Sphoorthy Engineering College (SPHN)
Hyderabad, India

ABSTRACT:- The security of one's belongings when a person leaves his/her house is always a concern with increasing number of incidents of theft, robbery etc. Many automated systems has been developed which informs the owner in a remote location about any intrusion or attempt to intrude in the house. 8051 has been extensively used in past projects. However, this paper looks into the development of an ANDROID application which interprets the message a mobile device receives on possible intrusion and subsequently a reply (Short Message Service) SMS which triggers an alarm/buzzer in the remote house making others aware of the possible intrusion.

Index Terms:- ANDROID, Short Message Service (SMS), Global Communication for mobile system (GSM).

I. INTRODUCTION

Controlling home appliances remotely with mobile applications have started becoming quite popular due to the exponential rise in use of mobile devices. There have been so many applications that exploit the use of GSM/GPRS facility of the handset [5]. Mobile handsets today are essentially handheld computers with integrated mobile radio communication capabilities. With increasing usage of GSM, network services are expanded beyond speech communication to incorporate many other custom applications, machine automation and machine to machine communication. This paper discusses an approach where an authorized remote mobile user receives an SMS when a third party tries to enter his house in a remote location. The minimum requirement at the user end is that the mobile device should have an ANDROID OS. ANDROID is a java based operating system which runs on the Linux 2.6 kernel. It's lightweight and full featured. ANDROID applications are developed using Java and can be ported to new platform easily thereby fostering huge number of useful mobile applications [6]. A hardware circuit with a switch and a GSM modem embedded is installed and connected to the door of the house. When the intruder tries to open the door, the switch triggers an interrupt and subsequently sends a signal into the microcontroller which subsequently triggers the GSM modem to transmit a warning SMS into already registered number in the modem. The SMS on the users' end is interpreted by the ANDROID Application and if it finds that the SMS is from the designated number; the application immediately informs the person with a frequent pop-up menu. If the user positive acknowledge the pop-up in 1 minute, an acknowledgement is send back to the remote GSM modem. The modem outputs an interrupt to the microcontroller and the microcontroller subsequently triggers an alarm. If the user fails to acknowledge in the defined time interval, an automatic positive acknowledgement is send by the application to the modem and the activities follow.

II. EXISTING METHODOLOGY

A lot many Home automation systems are available in the market. Different approach has been proposed at different times. However, Home automation system using ANDROID is still ongoing research project field. Google is trying to join home control arena with ANDROID application. Two of the approaches relevant to the topic are listed below.

A. Design and Implementation of Home Automation System [4].

In this paper presented by A. Alheraish, Member, IEEE, a design and implementation of remote control system by means of GSM cellular communication network is described. This design integrates the device to be controlled, the microcontroller, and GSM Module so that it can be used for a wide range of applications. The proposed M2M design in this paper uses a PC as the terminal user instead of microcontroller. In such a design, GSM dialup and communication protocol is embedded in the PC. The M2M microcontroller interacts with the M2M engine, embedded with the SIM card. The information that will be sent to the network has to be taken to a microcontroller to make the interface between the machine and M2M engine. They had used different modules

such as check and read message module ,which check any received message from the M2M module using AT commands, a decode module which decodes the text message and excludes all other details such as date, time and sender's name.

B. A mobile-based home automation system [3].

In this paper presented by M. Van Der Werff, X Gui, W.L. Xu, Massey University, New Zealand; they had proposed a system consisting of java-enabled mobile phone, a cellular modem, and a controller board incorporating a microcontroller. The mobile phone serves as a remote

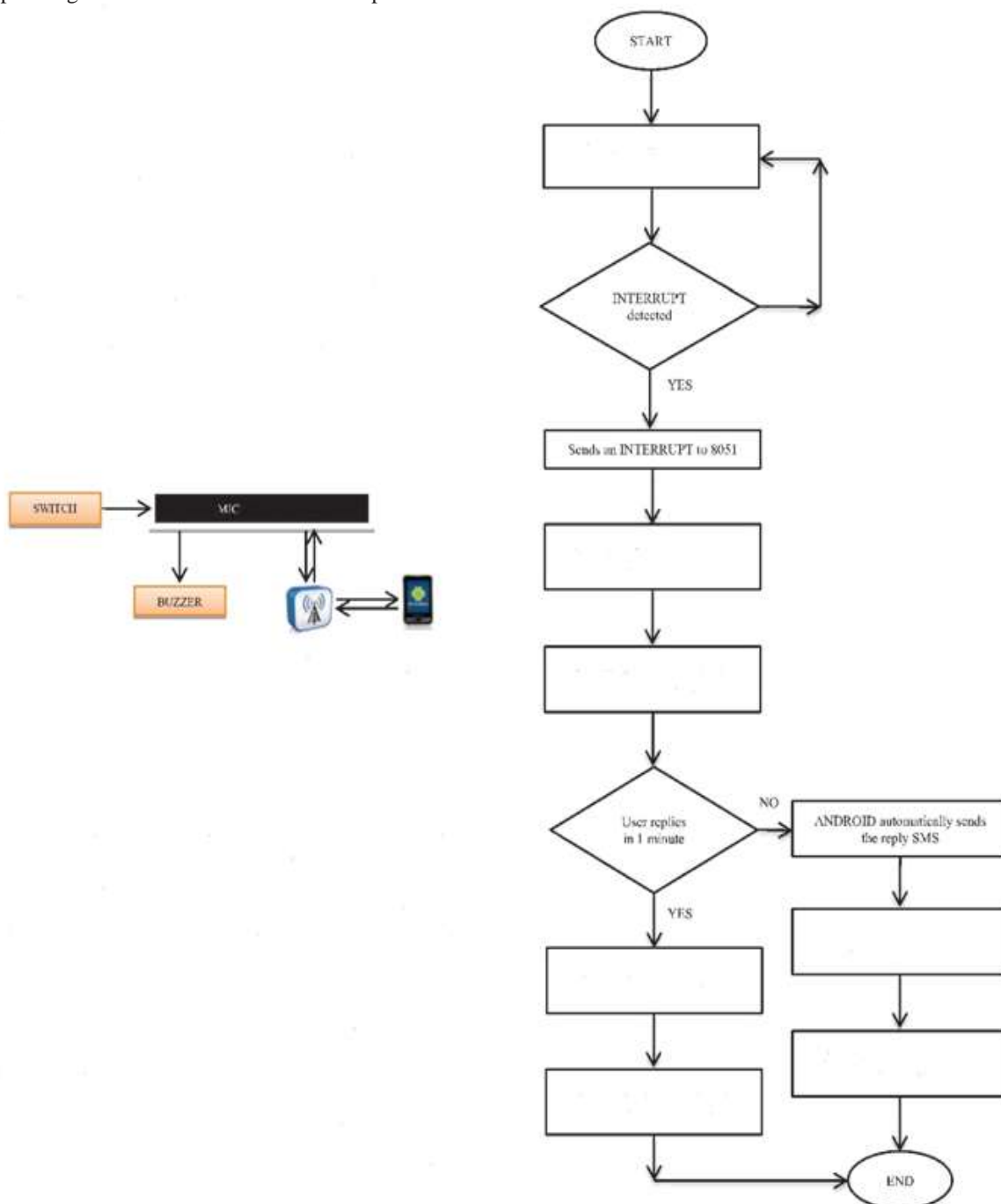

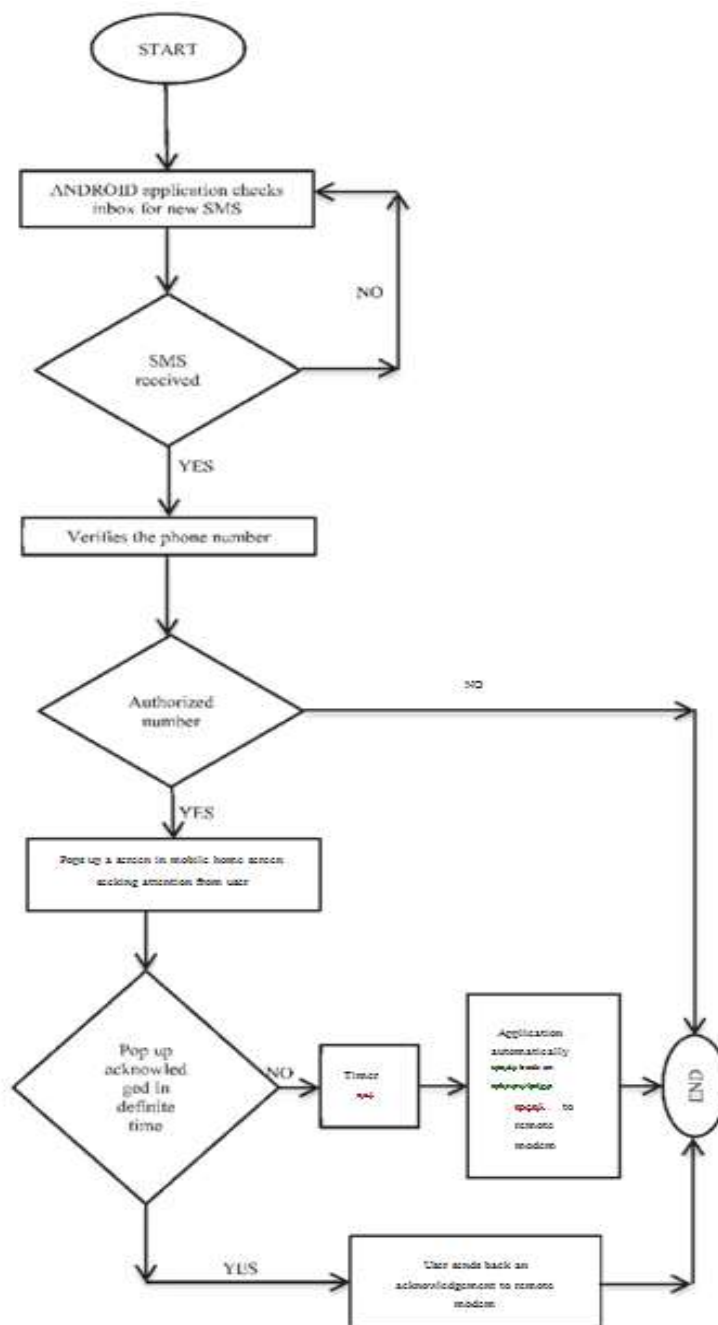

Fig. 3. Flowchart of the ANDROID application installed in mobile phone

III. HARDWARE IMPLEMENTATION

Fig. 5. describes the hardware implementation of the system. The circuit is designed in the simulation software; MultiSim version 11.00 developed by the software company National Instruments. In the initial phase the simulation was carried out using MultiSim. The wired circuit diagram shown in Fig. 5. is the simulation of the system. During the simulation we integrated the MAX232 IC and GSM modem (GSM modem IC unavailable in MultiSim; direct implementation was carried out during real-time hardware implementation) separately. But in real-time synthesis of the system the MAX232 IC was built-in with the GSM modem implying no separate use of MAX232 IC in real-time system. The real time system images (parts of real time system) are shown in Fig. 5. and the complete real-time system is shown in Fig. 4.

The methods designed in Flowcharts were properly implemented in this phase. The SWITCH monitors for any kind of INTERRUPT and signals the 8051 microcontroller (in this case the development board P89V51 RD2) shown in Fig. 4. The microcontroller in turn sends a digital signal (since microcontroller understands only TTL logic) [1] to the GSM modem which is received by the MAX232 IC incorporated inside the GSM modem

and converts it into an analog signal (since GSM modem; model number: SIM900; can only process analog signals) [2]. The GSM modem then sends a SMS to the user mobile phone (preferably supporting ANDROID OS) signaling that an intrusion has occurred. The SMS is then processed upon by the ANDROID application. When a proper reply is received at the modem again; depending upon the SMS the GSM modem will send a specific signal whether to play or do not play the buzzer (If YES is received; buzzer is not rung. Else if NO is received; buzzer is rung).

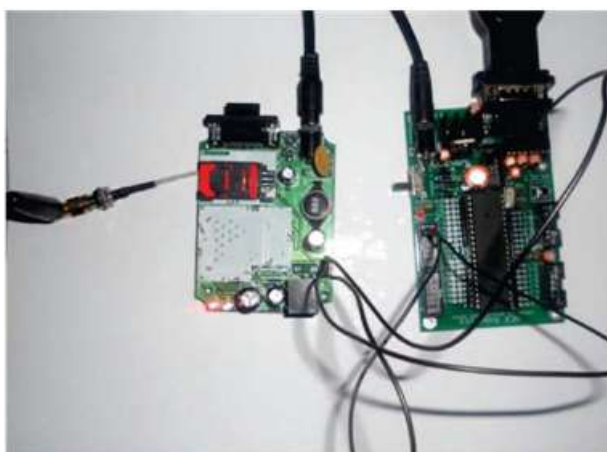

Fig. 4. The above image shows how the microcontroller sends SMS through the GSM modem to the mobile phone of the user. The right hand side circuit is the 8051 development board (p89V51 RD2) connected to the left hand side circuit which is the GSM modem (SIM900).

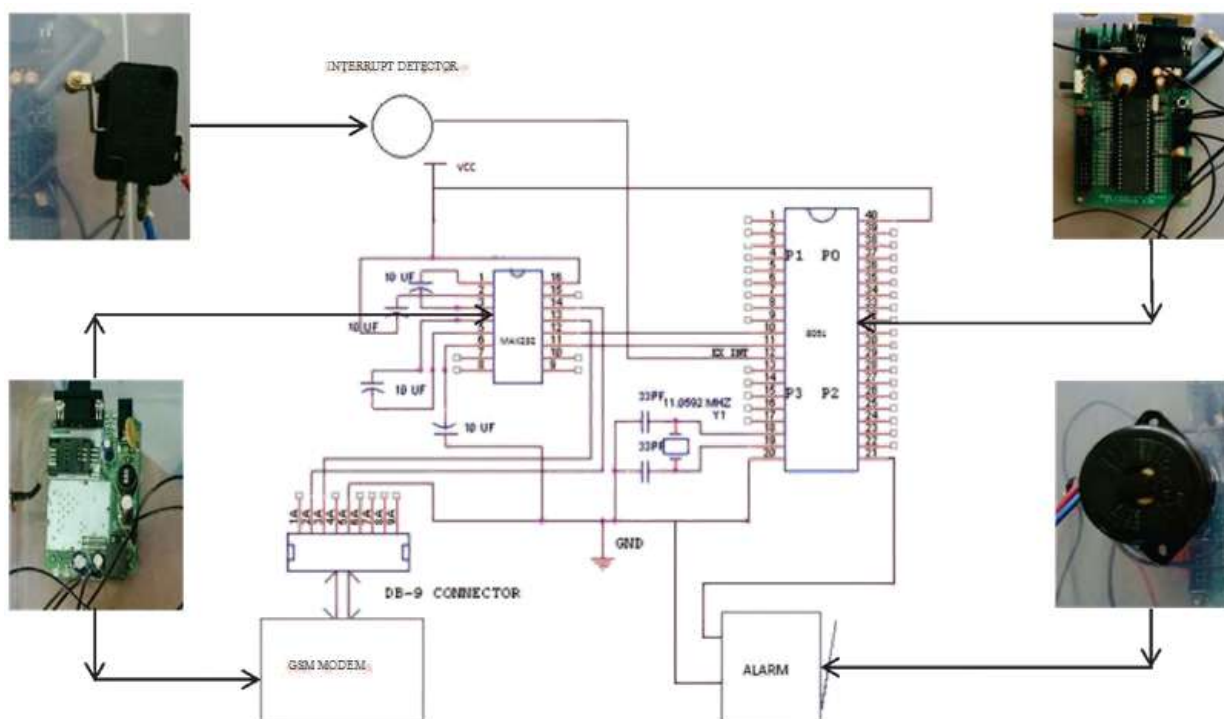

Fig. 5. Working Circuit Diagram designed in MultiSim for testing the Buzzer output on an interrupt input to the microcontroller. Hardware Circuit Diagram designed with actual hardware image labeled.

IV. ANDROID APPLICATION IMPLEMENTATION

Some sections of code of the MainActivity.java are listed below [7].

Packages used and MainActivity Class (not shown all):
 import java.io.FileOutputStream;

```
import android.app.Activity; import
android.app.AlertDialog; import
android.app.Dialog; import
android.os.Bundle; import
android.app.Activity; import
android.view.Menu;
import android.app.PendingIntent;
import android.content.Intent; import
android.telephony.*;

public class MainActivity extends Activity
{ Button BTN,ON,OFF;

IntentFilter intentFilter;
String s="";
EditText editText;
TextView textView;
FileOutputStream fos;
FileOutputStream fis;

String FILENAME="";
int condition=0;

private BroadcastReceiver intentReceiver = new
BroadcastReceiver() {

@Override

public void onReceive(Context context, Intent intent)

{
if (intent.getExtras().getString("SMS").equals(s))

{

Show Dialog (O);

if (condition==0)

{

sendSMS(s, "#PUMPON*");

}

}

}

}

@Override

protected void onCreate(Bundle savedInstanceState)

{

super.onCreate(savedInstanceState);
```

```
setContentView(R.layout.activity_main);
intentFilter=new IntentFilterO;
intentFilter.addAction("SMS_RECEIVED_ ACTION");
BTN =(Button) findViewById(R.id.BTN);

ON =(Button) findViewById(R.id.ON);
OFF =(Button) findViewById(R.id.OFF);
ON.setVisibility(View.INVISIBLE);
OFF.setVisibility(View.INVISIBLE);
edittext=(EditText) findViewById(R.id.edittext);
textview=(TextView) findViewById(R.id.textview);
BTN.setOnClickListener(new View. OnClickListener()
{ @Override

public void onClick(View arg0)

{ {

String temp="";
textview.setText("I");temp=edittext.getText().toString();edittext.setVisibility(View.INVISIBLE);

if(temp.length()<10)

{

textview.setText("Enter 10 digit number");

}

else{

BTN.setVisibility(View.INVISIBLE)

ON.setVisibility(View.VISIBLE);

OFF.setVisibility(View.VISIBLE);

textview.setText("I"); textview.setText(edittext.getText().toString() );s="+91"+textview.getText().toString();

textview.setText("Entered Number :"+S); showDialog( 1);
```

V. ANDROID APPLICATION OUTPUT SCREEN



Fig. 6. ANDROID application interface to enter the 10 digit mobile number.

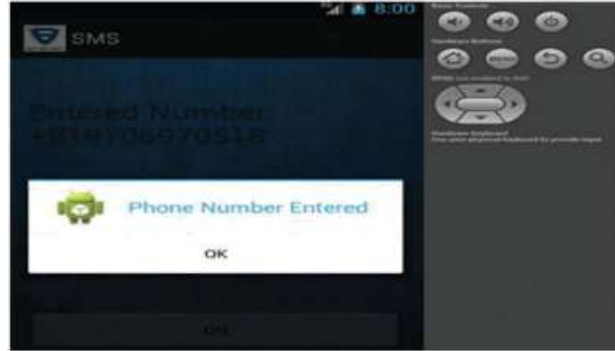

Fig. 7. Pop up after entering the 10 digit mobile number



Fig 8. Pop up on receiving an intrusion SMS from the saved number.

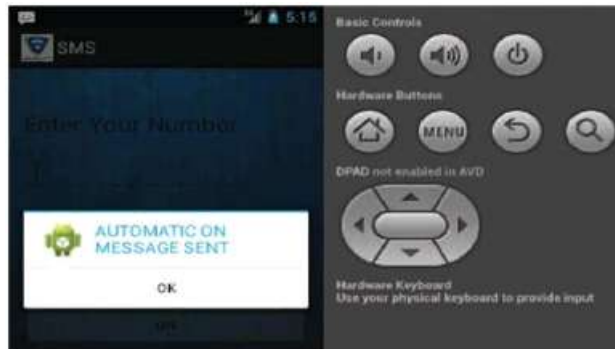

Fig 9. Automatic reply by the android system to trigger the alarm.

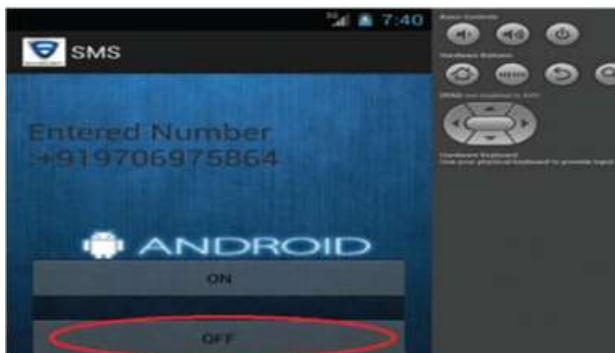

Fig. 10. On click of the off button, sends signals to the remote device and shuts down the buzzer.

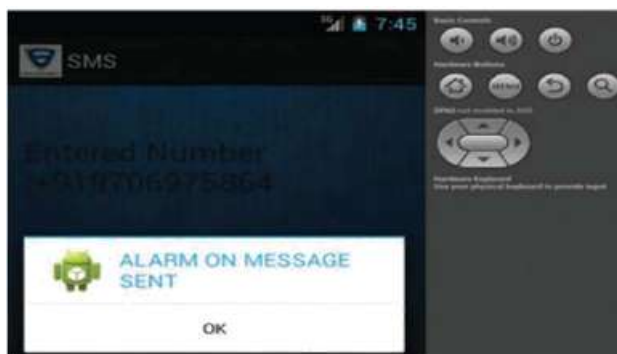

Fig. 11. Displays the message showing alarm triggering signal being sent to the remote device. The buzzer installed in the remote location starts ringing.

VI. CONCLUSION AND FUTURE WORK

The APK (ANDROID Application Package File) file have been deployed to ANDROID enabled mobile devices and tested. The hardware circuit meant to detect intrusion is installed. On interrupt intrusion, the GSM modem successfully sends a message to the ANDROID application installed in the mobile device. If the user fails to response in the defined time period, the application successfully sends a default message to the remote device, subsequently triggering the buzzer.

The application discussed here is sure to benefit every people who always have a doubt of their belongings being secure in the house in their absence. Most of the mobile devices that are manufactured nowadays in the market are ANDROID OS based. Taking this into interest the application has been developed in ANDROID and made user friendly, thereby making the application highly robust across different mobile devices and variety of users.

Certain features like triggering an electronic lock remotely rather than simply triggering the buzzer might be more useful to the users and will surely be taken care of in the near up gradation of the complete application. Also the system may be turned into a complete Home Automation System by implementing different sensors e.g. Motion Sensors, Gas Sensors, Temperature Sensors, etc. in the near future.

REFERENCES

- [1]. Mazidi, Mazidi&Mckinlay, "8051 Microcontroller& Embedded Systems", Pearson Education, 2nd Edition, 2006.
- [2]. Michael J. Pont, "Embedded C", Pearson Education, New York, 2002.
- [3]. M. Van Der Werff, X. Gui, and W.L. Xu "A Mobile Based Home Automation System", In Proceeding of IEEE 2nd International Conference on Mobile Technology Applications and Systems, pp. 1-5, 2005, Guangzhou, China.
- [4]. A. Alheraish, Member, IEEE "Design and Implementation of Home Automation System", IEEE Transactions on Consumer Electronics, Vol. 50, No. 4, pp. 1087-1092, November 2004.
- [5]. DhruvaJyotiGogoi, Rupam Kumar Sharma, "Android Based Emergency Alert Button", In International Journal of Innovative Technology and Exploring Engineering (IJITEE), ISSN: 2278-3075, Volume-2, Issue-4, pp. 26-27, March 2013.
- [6]. Josh Potts and SomsakSukittanon in "Exploiting Bluetooth on ANDROID Mobile Devices for Home Security Application", In Proceeding of IEEE Southeast Conference, pp. 1-4, March 2012, Orlando, Florida, USA.
- [7]. ArbabWaheed Ahmad, Naeem Jan, SaeedIqbal, Chankil Lee "Implementation of ZigBee-GSM based home security Monitoring and Remote Control System", In Proceeding of IEEE 54th International Midwest Symposium on Circuits and Systems (IEEE MWSCAS), 978-1-61284-857-0/111 © 2011 IEEE, Yonsei University, Seoul, Korea.
- [8]. Jun Hou, Chengdong Wu, Zhongjia Yuan, Jiyuan Tan, Qiaoqiao Wang, Yun Zhou, "Research of Intelligent Home Security Surveillance System Based on ZigBee",
- [9]. In Proceeding of IEEE 2nd International Symposium on Intelligent Information Technology Application Workshop (IITAW '08), pp. 554-557, December 2008, Shanghai, China.